

CATALOG IND-1

Effective June 1998

ROTARY SWITCHES for INDUSTRIAL APPLICATIONS

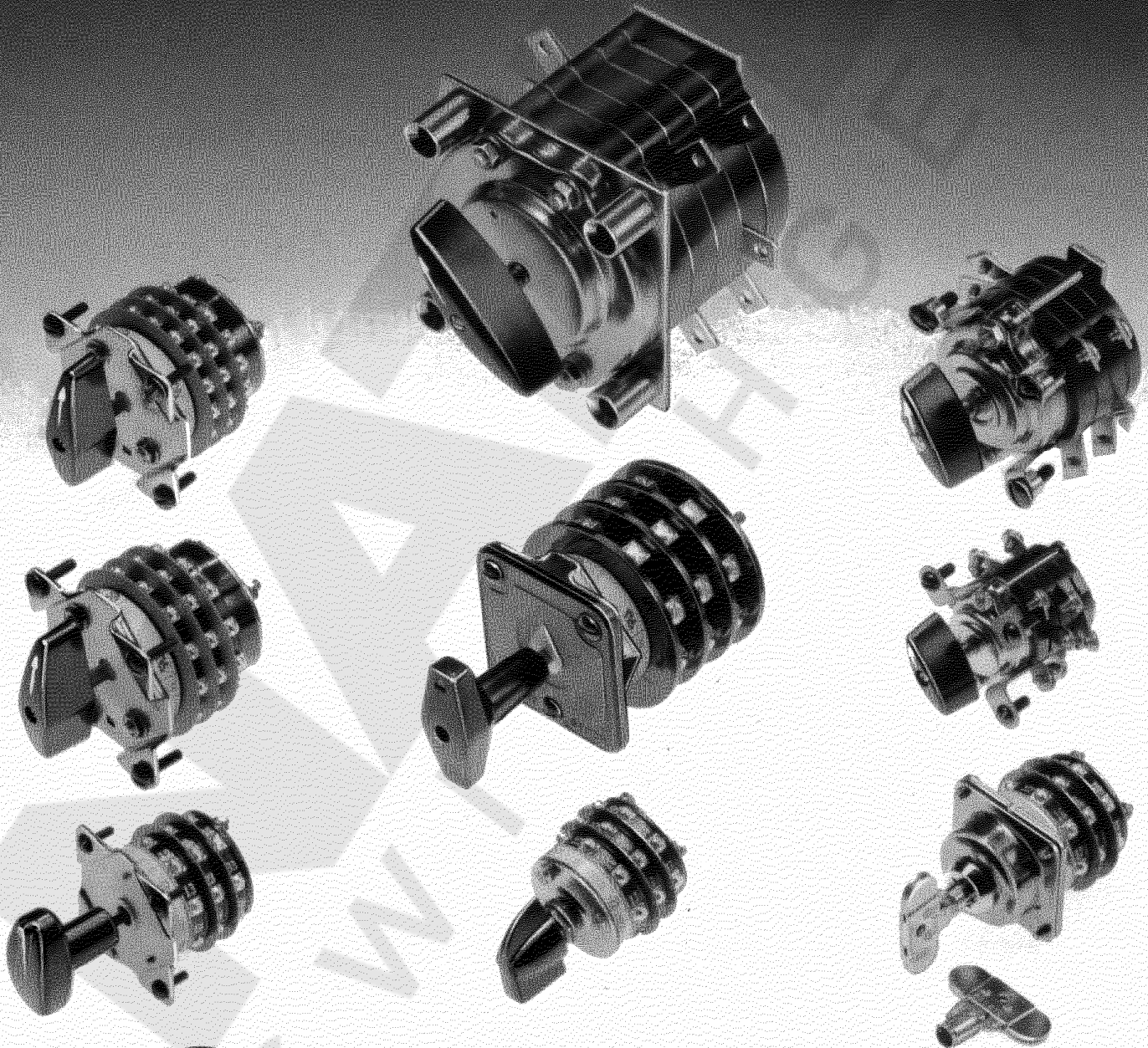

ELECTROSWITCH • SWITCHES & RELAYS

UNIT OF ELECTRO SWITCH CORP.

ROTARY SWITCHES FOR INDUSTRIAL APPLICATIONS

CONTENTS

SECTION I DETENT-ACTION SWITCHES







Basic Specifications/Selector Guide	1
Details of Construction	2
Testing	3
How to Order	4
Contact Assemblages & Diagrams.....	4 - 5
Series 21	6
Series 24	7
Series 25	8
Series 28	9
Series 31 4-hole mount.....	10
Series 31 Single-hole mount	11
Key-Lock & Key-Operated Switches.....	12
Solenoid-Lock & Push-to-Turn Switches.....	13
Spring-Return & Waterproof Mount.....	14
Typical Instrument Switches	15
Handles, Nameplates, Jumpers.....	16
Application Worksheet.....	17

SECTION II SNAP-ACTION SWITCHES

Basic Specifications/Selector Guide	18
Details of Construction	19
Testing	20
How to Order & Contact Diagrams	21
Series 101.....	22 - 23
Series 103.....	24 - 25
Series 105.....	26 - 27
Series 107.....	28 - 29
Typical Circuits & Instrument Switches.....	30
Application Worksheet.....	31
About Electros witch and Warranty.....	32

DETENT-ACTION SWITCHES

Basic Specifications

 CHARACTERISTICS	DETENT SWITCHES					
	SERIES 21	SERIES 24	SERIES 25	SERIES 28	SERIES 31	SERIES 31
     					Single-hole	4-hole
SECTIONS POLES POSITIONS DETENTING ANGLE	1-30 1-60 2-8 45°	1-10 1-20 2-8 45°	1-25 1-75 2-12 30°	1-15 1-30 2-16 22½°	1-10 1-20 2-8 45°	1-10 1-20 2-8 45°
ELECTRICAL RATINGS Continuous Rating Interrupting Current 120 VAC 240 VAC 600 VAC 24 VDC 125 VDC Max. Breaking Ability Max. Making Ability	15A-600V 15A 7½A 4A 10A 2A	30A-600V 20A 15A 6A 3A	10A-600V 10A 5A 3A 7½A	5A-600V 5A 3A 2A 5A	15A-600V 10A 5A 3A 5A 1A	15A-600V 10A 5A 3A 5A 1A
Momentary Current 1 second 3 seconds 30 seconds 60 seconds	140A 45A 35A	200A 75A 60A	75A 30A 25A		90A 35A 25A	90A 35A 25A
Overload Current (50 operations) 120 VAC 240 VAC 600 VAC 24 VDC 125 VDC	30A	95A 65A 35A	75A 20A	15A	60A 45A 20A 30A 15A	60A 45A 20A 30A 15A
Dielectric Strength Insulation Resistance Contact Resistance	2200 VRMS 100 megohms 10 milliohms	2200 VRMS 100 megohms 10 milliohms	2200 VRMS 100 megohms 10 milliohms	2200 VRMS 100 megohms 10 milliohms	2200 VRMS 100 megohms 10 milliohms	2200 VRMS 100 megohms 10 milliohms
MOUNTINGS Single-Hole 3-Hole 4-Hole Water proof-mount	Yes Yes	Yes Yes	Yes Yes	Yes Yes	Yes Yes	Yes
LOCKING FEATURES Key-interlock Push-to-turn Solenoid-lock	Yes Yes Yes	Yes Yes Yes	Yes Yes Yes	Yes Yes Yes		
SPECIAL DRIVES Key-operated Solenoid-operated Ganged gear-operated Spring return	Yes Yes	Yes Yes Yes Yes	Yes Yes	Yes Yes	Yes Yes	Yes Yes
APPROVALS UL Recognized CSA Certified	Yes Yes	Yes Yes	Yes Yes	Yes Yes	Yes Yes	Yes Yes

Features

- Up to 16 positions
- Up to 75 Poles (more if gear operated drive is utilized)
- Up to 30 amperes continuous rating
- UL Recognized & CSA Certified
- Positive Detent Action
- Silver to silver contacting
- Insulating materials — NEMA Class A (105°C)
- Most are available with the following features:
 - Water proof mount
 - Push to turn
 - Key Operated
 - Spring return
 - Solenoid lock
 - Key lock
 - Gear Operated
 - Solenoid Operated
- Double finger wiping contacts for low contact resistance and shock and vibration proof contacting
- All contact making and breaking takes place in fully enclosed decks



ELECTROSWITCH

UNIT OF ELECTRO SWITCH CORP. • Weymouth, Massachusetts 02188 • Telephone: (781) 335-5200 • FAX: (781) 335-4253

DETENT-ACTION SWITCHES

Details of Construction

Electroswitch Detent Switches

are heavy-duty switches of a very versatile design that enables standard units to satisfy a great variety of complex switching applications. They are modular in design whereby several subassemblies are stacked together to form a rigid rugged device. Figure 1 shows a cut-away view exposing the basic components.

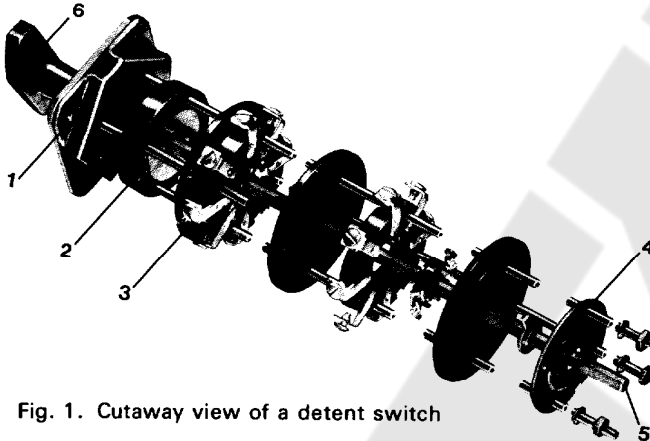

Fig. 1. Cutaway view of a detent switch

The mounting plate (1) connects a detent assembly (2) to one or more contact decks (3) and finally a position limiting stop plate (4). These assemblies are bolted together along with a steel shaft (5) and a handle (6).

The Electrical Design

The Detent Switch contacts operate on the original, reliable principle of knife switches — double-sided, double-wiping, spring-wiper blades closing on both sides of a terminal. This design is shock-proof and virtually bounce-proof. Figure 2 shows a typical contacting arrangement.

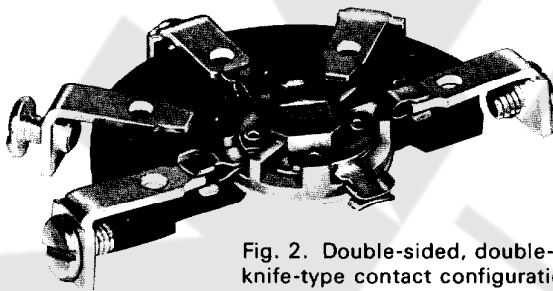
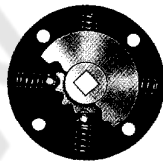

Fig. 2. Double-sided, double-wiping knife-type contact configuration

The Detent Assembly

The detent assembly contains a specially designed star-wheel and up to four spring-loaded ball bearings providing snappy positive indexing. Spring-return switches use a coil spring in place of the star-wheel/spring/ball bearing arrangement.



The Contact Deck Assembly

The electrical parts are contained within sturdy phenolic moldings that provide individual insulated compartments where all switching takes place.

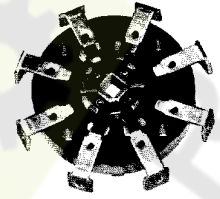

An insulating barrier completes the contact deck assembly. The barrier not only separates one contact assembly from another but also provides a tight insulating compartment. With this construction there is no need to add a dust cover.

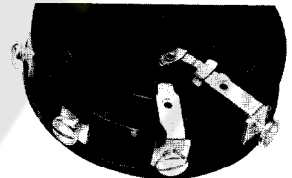

Positive reliable maintenance free operation results from the double-sided, double-wiping, self-cleaning knife-blade moveable contacts.



The barrier next to the stationary terminals is clearly marked with letters for series 21, 25, 28, numerals for series 24 and 31, that correspond with the wiring diagrams.



Terminal screws secure the external wiring to the terminals.

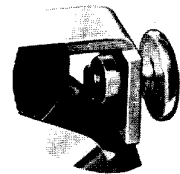

Jumpering may be done right on the switch providing a simple and neat arrangement. Silver-plated brass strap jumpers are available for adjacent contacts — either between adjacent contacts on the same deck or the same terminal location on adjacent decks. Wire and lug jumpers are also available. Jumpers are already supplied assembled on the typical instrument switches illustrated on page 15 simplifying field wiring. All you need to do is connect the instrument leads and the line wires.

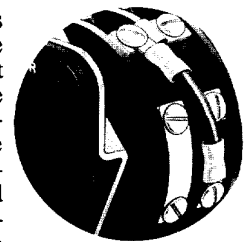

The Stop Plate

The steel stop plate assembly includes a steel stop arm that is connected to the shaft and a steel stop plate that contains tapped holes. Stop screws are inserted in the field to limit the positions to the number and location desired. This externally adjustable position limiting feature allows the use of standard switches for many customized applications. The limit screws are supplied unassembled in the typical instrument switches.

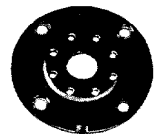

UNIT OF ELECTRO SWITCH CORP. • Weymouth, Massachusetts 02188 • Telephone: (781) 335-5200 • FAX: (781) 335-4253

ALL ABOUT TESTING OF DETENT SWITCHES

Switches are tested in many ways to prove their capabilities and reliability. Electroswitch uses a combination of test methods to provide meaningful data for all applications. These include:

1. Cycle it mechanically until it breaks. This is usually an academic test since switches that do not switch electric power are not needed. An exception is a set-up switch whereby the switch sets up a complicated circuit and then a circuit breaker switches the power. All testing of detent switches is done under electrical load.
2. Test under an application oriented specification - something that simulates actual operating conditions such as environment, overloads, surges, etc. UL1054 on SPECIAL USE SWITCHES and CSA C22.2 on INDUSTRIAL CONTROL EQUIPMENT for use in Ordinary (non-hazardous) Locations are probably the best specifications in widespread use. The series 21, 24, 25, 28 and 31 are UL recognized and CSA certified to these specifications.
3. Test at different ratings until destruction to determine ultimate life (destruction could be mechanical failure, shorting out, dielectric failure, excessive heat rise, etc.) The test conditions are outlined on the SELECTOR CHART on page 1. The results are summarized below:

Both UL and CSA testing consists of two parts:

1. Product testing to the specifications.
2. Follow-up service by UL and CSA personnel at the factory, including inspection and testing to insure that the quality and reliability is maintained.

If all conditions are met, the switches are considered "certified electrical equipment" by CSA and "recognized components" by UL and the applications are subject to review by these agencies to assure suitability.

UL AND CSA RATINGS

SERIES	UL Recognized	CSA Certified
21	15A - 120 VAC 7½A - 240 VAC 4A - 600 VAC	10A - 125 VAC
24	20A - 120 VAC 15A - 240 VAC 6A - 600 VAC 3A - 125 VDC 1A - 250 VDC	20A - 600 VAC 10A - 30 VDC 2A - 125 VDC 2HP - 240/480 VAC
25	10A - 120 VAC 5A - 240 VAC 3A - 600 VAC	7½A - 125 VAC
28	5A - 120 VAC 3A - 240 VAC 2A - 600 VAC	5A - 125 VAC
31	10A - 125 VAC 5A - 250 VAC 3A - 600 VAC 5A - 30 VDC 1A - 125 VDC	10A - 125 VAC 5A - 250 VAC

These recognized or certified ratings are not necessarily the limits of switch capacity. They represent the acceptable tested ratings to comply with individual standards.

Tests include:

1. Overload -- 50 cycles of operation.
UL -- 0-10A at 150% rating ... over 10A, 125% rating
CSA -- 150% rating
2. Endurance -- 6000 operations
(DC resistive; AC at .75 to .80 pf)
3. Temperature rise of contacts - 30° max. at maximum continuous current rating
4. Dielectric Voltage Withstand UL - 2200VRMS
5. Spacings (between live parts or live parts to ground)
UL - 0-250V (3/64 in. min.). 251-600V (1/8 in. min.)

CSA	through air	over surface
51-150V	.12 inches	.25 inches
151-300V	.25	.37
301-600V	.37	.50

LIFE EXPECTANCY under ELECTRICAL LOAD – make & break operations

These tables show the results of life-tests performed in our standardization laboratory under a variety of service conditions.

SWITCH SERIES	Amps	Alternating Current – 60 Hz						Direct Current			
		125 VAC		250 VAC		600 VAC		24 VDC		125 VDC	
		Resistive	Inductive	Resistive	Inductive	Resistive	Inductive	Resistive	Inductive	Resistive	Inductive
21	10	40,000	40,000	—	—	—	—	40,000	—	—	—
	5	—	—	40,000	40,000	—	—	—	—	—	—
	2	—	—	—	—	—	—	—	—	40,000	—
24	20	10,000	10,000	10,000	10,000	10,000	10,000	—	—	—	—
	3	—	—	—	—	—	—	—	—	10,000	10,000
25	7½	40,000	40,000	—	—	—	—	40,000	—	—	—
	3	—	—	40,000	40,000	—	—	—	—	—	—
28	5	40,000	40,000	—	—	—	—	40,000	—	—	—
	2	—	—	40,000	40,000	—	—	—	—	—	—
31	10	22,000	18,000	—	—	—	—	7,000	—	—	—
	5	42,000	38,000	22,000	18,000	—	—	38,000	10,000	—	—
	3	52,000	48,000	32,000	28,000	—	—	48,000	20,000	—	—
	1	70,000	65,000	50,000	45,000	30,000	25,000	65,000	37,000	40,000	15,000
	0.5	75,000	70,000	55,000	50,000	35,000	30,000	70,000	42,000	50,000	30,000

Hot-filament load – series 31 for 40,000 operations at 3A-125 VAC

Inductive loads – AC (60-400 Hz) – power factor: to 0.75

DC – 24 VDC at .15 henry, 125 VDC at .075 henry



ELECTROSWITCH

UNIT OF ELECTRO SWITCH CORP. • Weymouth, Massachusetts 02188 • Telephone: (781) 335-5200 • FAX: (781) 335-4253

HOW TO ORDER:

BASIC NUMBERING SYSTEM

Standard Switches - Each Catalog Number identifies a specific switch that is furnished with the contact assemblage and handle as shown on pages 6 to 11.

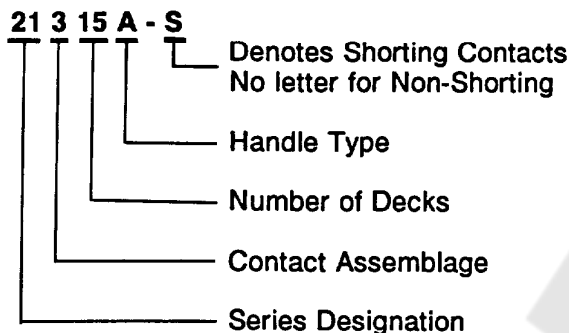

Non-Standard Switches - The following codes are used to specify variations from Standard Switch Numbers.

21915 LA or 001

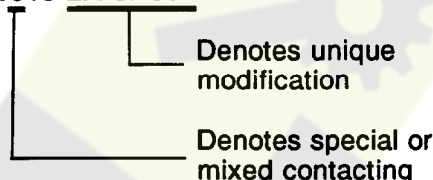

SPECIAL PURPOSE SWITCHES

When the application requires a switch not shown in this catalog, please complete the Application Worksheet on Page 17 and forward to the factory.

Standard Contact Assemblages and Diagrams

The contact diagrams are shown for 8 position switches, Series 21, 24 & 31. Other detent switches which have more than eight positions (Series 25 has 12 and Series 28 has 16) will have similar contact diagrams except with more positions.

The Series 21 shows the alphabet markings of terminals on the 21, 25 & 28. The Series 24 and 31 (both single and 4-hole mounts) have the numerical terminal markings as shown.

The many Contacting Variations that can be utilized with Electroswitch Detent Switches and which can be combined in the same switch are shown in the assemblage diagrams below. All are shown with the handle in the 12 o'clock (0°) position. They can be furnished with either make-before-break (shorting) or break-before-make (non-shorting) contacts except as noted below.

Assemblage 2

Two poles per section; double-break switching. This assemblage is normally limited to three positions.

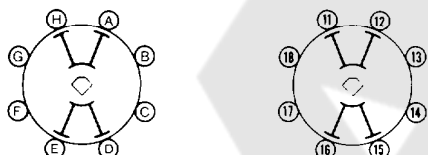

SERIES 21

SERIES 24 & 31

DECK	CONTACTS HANDLE END	POSITIONS			DECK	CONTACTS HANDLE END
		1	2	3		
1	H-O				1	11-O
	A-O					12-O
	B-O					13-O
	D-O					15-O
	E-O					16-O
	F-O					17-O
						18-O

Assemblage 3

One pole per section; provides "OFF" and 7 tap positions.

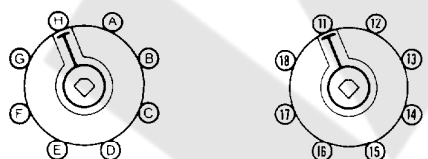

SERIES 21

SERIES 24 & 31

DECK	CONTACTS HANDLE END	POSITIONS								DECK	CONTACTS HANDLE END
		OFF	1	2	3	4	5	6	7		
1	H-O									1	12-O
	A-O										13-O
	B-O										14-O
	D-O										15-O
	E-O										16-O
	F-O										17-O
	G-O										18-O

Assemblage 11

Allows any one circuit to be opened while the rest are closed; make-before-break (shorting) only.

This assemblage is not available in Series 28.

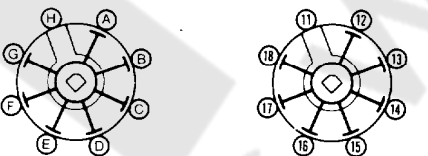

SERIES 21

SERIES 24 & 31

DECK	CONTACTS HANDLE END	POSITIONS								DECK	CONTACTS HANDLE END			
		1	*	2	*	3	*	4	*			5	*	6
1	H-O									1	12-O			
	A-O										13-O			
	B-O										14-O			
	D-O										15-O			
	E-O										16-O			
	F-O										17-O			
	G-O										18-O			

Non-standard Contact Assemblages and Diagrams

Available with Factory Authorization only.

Assemblage 1

One pole per section; double-break switching.

SERIES 21

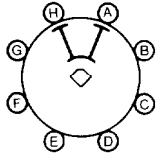

SERIES 24 & 31

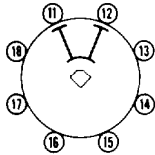

SERIES 21

DECK	CONTACTS HANDLE END	POSITIONS								DECK
		1	2	3	4	5	6	7	8	
1	H O O A	x								1
	A O O B		x							
	B O O C			x						
	C O O D				x					
	D O O E					x				
	E O O F						x			
	F O O G							x		
	G O O H								x	

SERIES 24 & 31

DECK	CONTACTS HANDLE END	POSITIONS								DECK
		1	2	3	4	5	6	7	8	
1	11 O O 12									1
	12 O O 13									
	13 O O 14									
	14 O O 15									
	15 O O 16									
	16 O O 17									
	17 O O 18									
	18 O O 11									

Assemblage 5

Three poles per section; double-break switching. This assemblage is available in, and shown for Series 25 only.

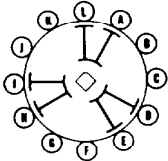

SERIES 25

DECK	CONTACTS HANDLE END	POSITIONS		
		1	2	3
1	L O O A	x		
	A O O B		x	
	B O O C			x
	D O O E	x		
	E O O F		x	
	F O O G			x
	H O O I	x		
	I O O J		x	
	J O O K			x

Assemblage 6

Cumulative tap switch; make-before-break (shorting) only. This assemblage is normally limited to four positions.

SERIES 21

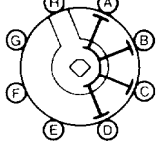

SERIES 24 & 31

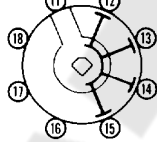

SERIES 21

DECK	CONTACTS HANDLE END	POSITIONS				DECK		
		1	*	2	*		3	*
1	H O O A	x	x			1		
	A O O B	x	x	x	x			
	O C	x	x	x	x		x	
	O D	x	x	x	x		x	
	O E	x	x	x	x		x	
	O F			x	x		x	x
	O G				x		x	x

SERIES 24 & 31

DECK	CONTACTS HANDLE END	POSITIONS				DECK	
		1	*	2	*		3
1	12 O O 11					1	
	13 O O 11						
	14 O O 11						
	15 O O 11						
	16 O O 11						
	17 O O 11						
	18 O O 11						

Assemblage 7

Provides double-break switching. This assemblage is normally limited to four positions.

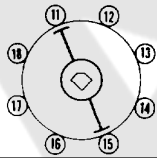
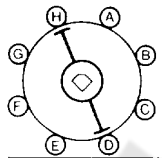

SERIES 21

DECK	CONTACTS HANDLE END	POSITIONS				DECK
		1	2	3	4	
1	H O O D	x				1
	A O O E		x			
	B O O F			x		
	C O O G				x	

SERIES 24 & 31

DECK	CONTACTS HANDLE END	POSITIONS				DECK
		1	2	3	4	
1	11 O O 15					1
	12 O O 16					
	13 O O 17					
	14 O O 18					

Assemblage 8

Allows pairs of circuits to be fed from a common source.

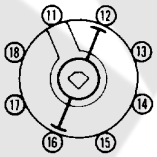
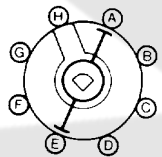

SERIES 21

DECK	CONTACTS HANDLE END	POSITIONS			DECK
		1	2	3	
1	H O O A	x			1
	A O O B		x		
	O C			x	
	O D				
	O E	x			
	O F		x		
	O G			x	

SERIES 24 & 31

DECK	CONTACTS HANDLE END	POSITIONS				DECK
		1	2	3	4	
1	12 O O 11					1
	13 O O 11					
	14 O O 11					
	15 O O 11					
	16 O O 11					
	17 O O 11					
	18 O O 11					

Assemblage 10

Same as Assemblage 3 except first position is "On".

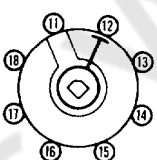
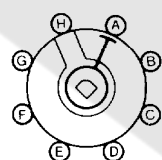

SERIES 21

DECK	CONTACTS HANDLE END	POSITIONS							DECK
		1	2	3	4	5	6	7	
1	H O O A	x							1
	A O O B		x						
	O C			x					
	O D				x				
	O E					x			
	O F						x		
	O G							x	

SERIES 24 & 31

DECK	CONTACTS HANDLE END	POSITIONS							DECK
		1	2	3	4	5	6	7	
1	12 O O 11								1
	13 O O 11								
	14 O O 11								
	15 O O 11								
	16 O O 11								
	17 O O 11								
	18 O O 11								



UNIT OF ELECTRO SWITCH CORP. • Weymouth, Massachusetts 02188 • Telephone: (781) 335-5200 • FAX: (781) 335-4253

SERIES 21

- 2-8 POSITIONS
- 15A/600VAC CONTINUOUS

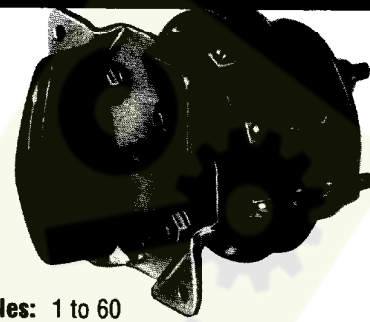

ELECTRICAL

Interrupting Ratings:

15A/120VAC, 60 to 400 cps, 0.8 pf, inductive load
 7.5A/240VAC, 60 to 400 cps, 0.8 pf, inductive load
 4A/600VAC, 60 to 400 cps, 0.8 pf, inductive load

Overload: 50 operations @ 30A/125VAC, resistive

Dielectric breakdown: 2200V rms minimum

Insulation resistance: 100 megohms minimum

Contact resistance: 30 milliohms max.

(10 milliohms average before life)

Electrical life: 40,000 make and break operations

MECHANICAL

Sections: 1 to 30 **Poles:** 1 to 60

Positions: 8; adjustable stops for 2-8 position limited rotation

Contacts: break-before-make (non-shorting); make-before-break (shorting)

Action: 45° positive detent indexing

Mounting: panel-mount, four tapped mounting holes

Panel thickness: 3/16 standard

Rotor contacts: phosphor-bronze, silver plated, double-grip

Stationary contacts: silver plated copper, integral with screw-type terminals

Construction: contacts enclosed in molded-phenolic disks

Assemblage 2

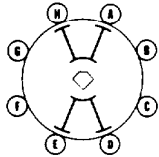

Assemblage 3

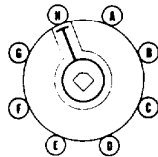

Nominal torques, weights, and depth behind panel are listed below.

assemblages are shown with handle in 0° position (12 o'clock)

No. Sec.	Cat. No.	No. Sec.	Cat. No.	Nominal Torques		Depth behind Panel-inches
				Weight lbs.	Torque lb.-in.	
1	21201A	1	21301A	1.1	8	2.00
2	21202A	2	21302A	1.2	9	2.34
3	21203A	3	21303A	1.3	10	2.72
4	21204A	4	21304A	1.4	11	3.09
5	21205A	5	21305A	1.5	12	3.47
6	21206A	6	21306A	1.6	13	3.72
7	21207A	7	21307A	1.7	14	4.22
8	21208A	8	21308A	1.8	15	4.59
9	21209A	9	21309A	1.9	16	4.97
10	21210A	10	21310A	2.0	17	5.34
11	21211A	11	21311A	2.1	18	5.59
12	21212A	12	21312A	2.2	19	6.09
13	21213A	13	21313A	2.3	20	6.47
15	21215A	15	21315A	2.8	29	7.72
20	21220B	20	21320B	3.4	34	9.47
25	21225B	25	21325B	4.0	39	11.47
30	21230B	30	21330B	4.9	57	14.09

Features...



UL File No. E18174

Additional contact assemblages are available on request. See page 4 & 5.

For switches with 1 to 15 sections, the flush handle with arrow is standard (per photograph); above 15 sections, the shank handle with arrow (see "handles" page) is standard.

For make-before-break (shorting) contacts:
add "S" (e.g. 21201A-S).

Nameplates are optional and are only supplied if requested at additional cost.

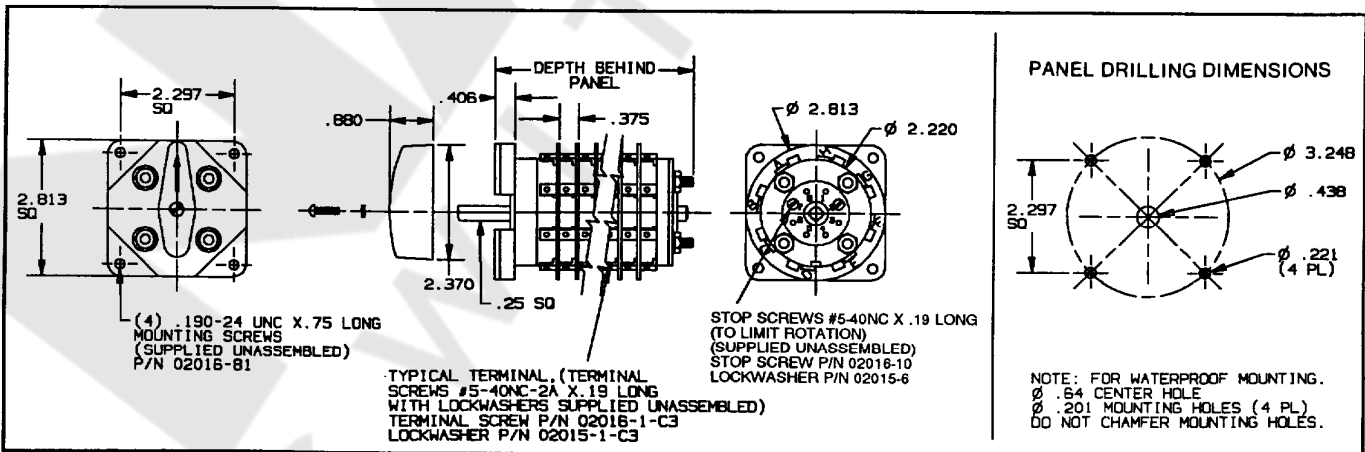

UNIT OF ELECTRO SWITCH CORP. • Weymouth, Massachusetts 02188 • Telephone: (781) 335-5200 • FAX: (781) 335-4253

SERIES 24

- 2-8 POSITIONS
- 30A/600VAC CONTINUOUS

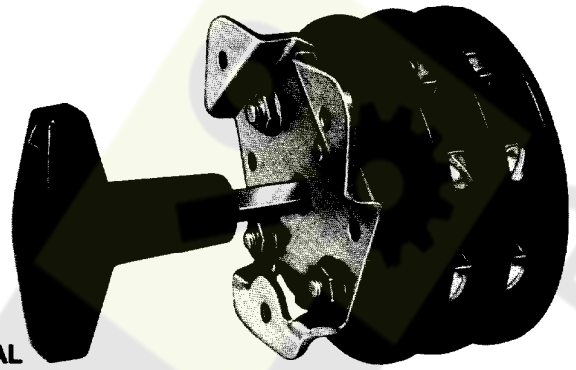

ELECTRICAL

Interrupting Ratings:

20A/120VAC
15A/240VAC
6A/600VAC
3A/125VDC
1A/250VDC

Overload: 50 operations @ 95A/125VAC

50 operations @ 65A/240VAC

50 operations @ 35A/600VAC

MECHANICAL

Sections: 1 to 10 **Poles:** 1 to 20

Positions: 8; adjustable stops for 2-8 position limited rotation

Contacts: break-before-make (non-shorting); make-before-break (shorting)

Action: 45° positive detent indexing

Mounting: panel-mount, three tapped mounting holes

Panel thickness: 3/16 standard

Rotor contacts: silver overlay phosphor-bronze, double-grip

Stationary contacts: silver overlay copper, integral with screw-type terminals

Construction: contacts enclosed in molded-phenolic disks

Assemblage 2

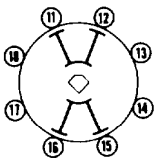

Assemblage 3

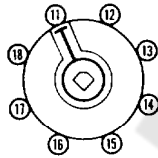

Nominal torques, weights, and depth behind panel are listed below.

assemblages are shown with handle in 0° position (12 o'clock)

No. Sec.	Cat. No.	No. Sec.	Cat. No.	Weight lbs.	Torque lb.-in.	Depth behind Panel-inches
1	24201B	1	24301B	1.1	8	2.41
2	24202B	2	24302B	1.2	9	2.78
3	24203B	3	24303B	1.3	10	3.53
4	24204B	4	24304B	1.4	11	4.28
5	24205B	5	24305B	1.5	12	4.66
6	24206B	6	24306B	1.6	13	5.41
7	24207B	7	24307B	1.7	14	6.16
8	24208B	8	24308B	1.8	15	6.53
9	24209B	9	24309B	1.9	16	7.41
10	24210B	10	24310B	2.0	17	8.03

Features...



UL File No. E18174

Additional contact assemblages are available on request. See pages 4 & 5.

For make-before-break (shorting) contacts:
add "S" (e.g. 24201B-S).

Nameplates are supplied at no additional cost.

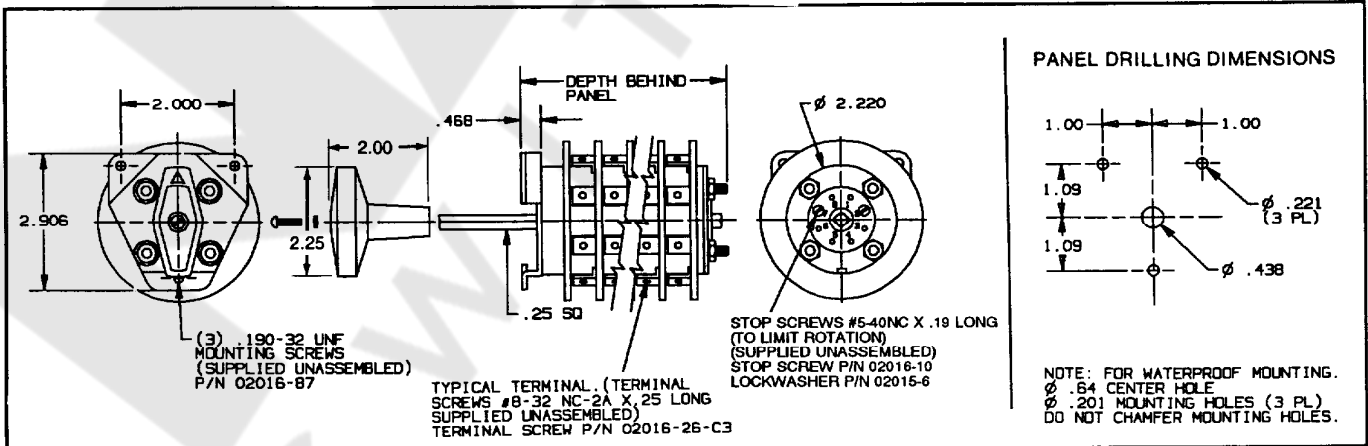

UNIT OF ELECTRO SWITCH CORP. • Weymouth, Massachusetts 02188 • Telephone: (781) 335-5200 • FAX: (781) 335-4253

SERIES 25

- 2-12 POSITIONS
- 10A/600VAC CONTINUOUS



ELECTRICAL

Interrupting Ratings:

10A/120VAC, 60 to 400 cps, 0.8 pf, inductive load

5A/240VAC, 60 to 400 cps, 0.8 pf, inductive load

3A/600VAC, 60 to 400 cps, 0.8 pf, inductive load

Overload: 50 operations @ 22A/125VAC, resistive

Dielectric breakdown: 2200V rms minimum

Insulation resistance: 100 megohms minimum

Contact resistance: 10 milliohms max.

(3 milliohms average before life)

Electrical life: 40,000 make and break operations

MECHANICAL

Sections: 1 to 25 **Poles:** 1 to 75

Positions: 12; adjustable stops for 2-12 position limited rotation

Contacts: break-before-make (non-shorting); make-before-break (shorting)

Action: 30° positive detent indexing

Mounting: panel-mount, four tapped mounting holes

Panel thickness: 3/16 standard

Rotor contacts: silver-overlay phosphor-bronze, double-grip

Stationary contacts: silver-overlay copper, integral with screw-type terminals

Construction: contacts enclosed in molded-phenolic disks

Assemblage 3

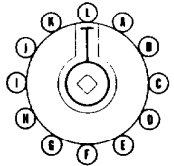

Assemblage 5

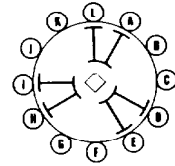

Nominal torques, weights, and depth behind panel are listed below.

assemblages are shown with handle in 0° position (12 o'clock)

No. Sec.	Cat. No.	No. Sec.	Cat. No.	Weight lbs.	Torque lb.-in.	Depth behind Panel-inches
1	25301A	1	25501A	1.1	9	1.97
2	25302A	2	25502A	1.2	10	2.34
3	25303A	3	25503A	1.3	11	2.72
4	25304A	4	25504A	1.4	12	3.09
5	25305A	5	25505A	1.5	13	3.47
6	25306A	6	25506A	1.6	14	3.84
7	25307A	7	25507A	1.7	15	4.22
8	25308A	8	25508A	1.8	16	4.59
9	25309A	9	25509A	1.9	17	4.97
10	25310A	10	25510A	2.0	18	5.34
11	25311A	11	25511A	2.1	19	5.59
12	25312A	12	25512A	2.2	20	6.09
13	25313A	13	25513A	2.3	21	6.47
14	25314A	14	25514A	2.4	22	6.84
15	25315A	15	25515A	2.8	30	7.72
20	25320B	20	25520B	3.4	35	9.97
25	25325B	25	25525B	4.0	40	11.47

Features...



UL File No. E18174

Additional contact assemblages are available on request. See pages 4 & 5.

For switches with 1 to 15 sections, the flush handle with arrow is standard (per photograph); above 15 sections, the shank handle with arrow (see "handles" page) is standard.

For make-before-break (shorting) contacts:
add "S" (e.g. 25301A-S).

Nameplates are optional and are only supplied if requested at additional cost.

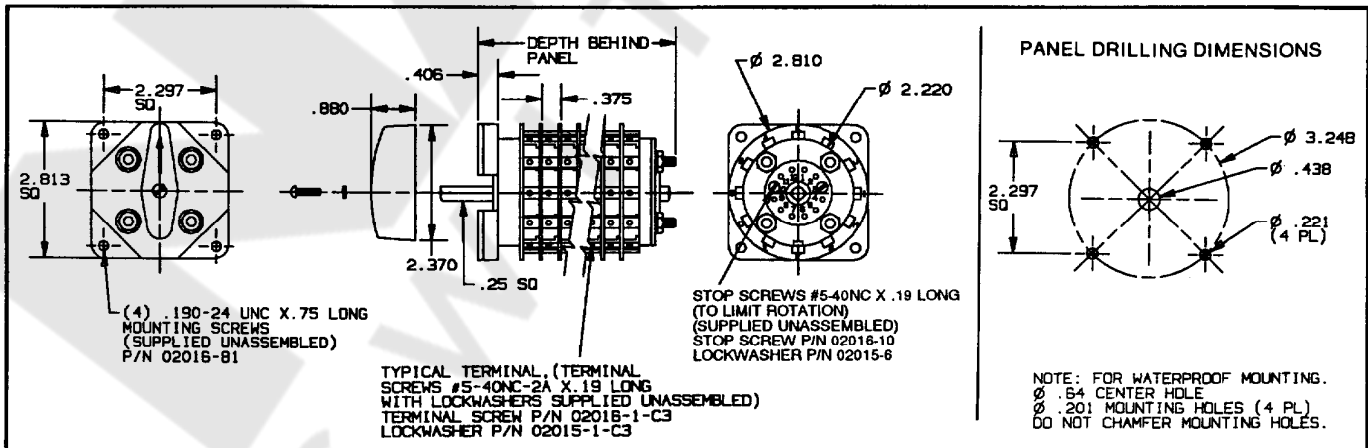

ELECTROSWITCH

UNIT OF ELECTRO SWITCH CORP. • Weymouth, Massachusetts 02188 • Telephone: (781) 335-5200 • FAX: (781) 335-4253

SERIES 28

- 2-16 POSITIONS
- 5A/600VAC CONTINUOUS



ELECTRICAL

Interrupting Ratings:

- 5A/120VAC, 60 to 400 cps, 0.8 pf, inductive load
- 3A/240VAC, 60 to 400 cps, 0.8 pf, inductive load
- 2A/600VAC, 60 to 400 cps, 0.8 pf, inductive load

Overload: 50 operations @ 15A/125VAC, resistive

Dielectric breakdown: 2200V rms minimum

Insulation resistance: 100 megohms minimum

Contact resistance: 10 milliohms max.
(3 milliohms average before life)

Electrical life: 40,000 make and break operations

MECHANICAL

Sections: 1 to 15 **Poles:** 1 to 30

Positions: 16; adjustable stops for 2-16 position limited rotation

Contacts: break-before-make (non-shorting); make-before-break (shorting)

Action: 22½° positive detent indexing

Mounting: panel-mount, four tapped mounting holes

Panel thickness: 3/16 standard

Rotor contacts: silver-overlay phosphor-bronze, double-grip

Stationary contacts: silver-overlay copper, integral with screw-type terminals

Construction: contacts enclosed in molded-phenolic disks

Assemblage 3

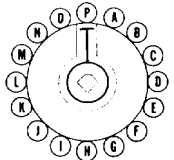

Nominal torques, weights, and depth behind panel are listed below.

Assemblage is shown with handle in 0° position (12 o'clock)

No. Sec.	Cat. No.	Weight lbs.	Torque lb.-in.	Depth behind Panel-inches
1	28301A	1.1	9	1.97
2	28302A	1.2	10	2.34
3	28303A	1.3	11	2.72
4	28304A	1.4	12	3.09
5	28305A	1.5	13	3.47
6	28306A	1.6	14	3.84
7	28307A	1.7	15	4.22
8	28308A	1.8	16	4.59
9	28309A	1.9	17	4.97
10	28310A	2.3	25	5.72
11	28311A	2.4	26	6.09
12	28312A	2.5	27	6.47
13	28313A	2.6	28	6.84
14	28314A	2.7	29	7.34
15	28315A	2.8	30	7.72

Features...



UL File No. E18174

For switches with 1 to 15 sections, the flush handle with arrow is standard (per photograph).

For make-before-break (shorting) contacts:
add "S" (e.g. 28301A-S).

Nameplates are optional and are only supplied if requested at additional cost.

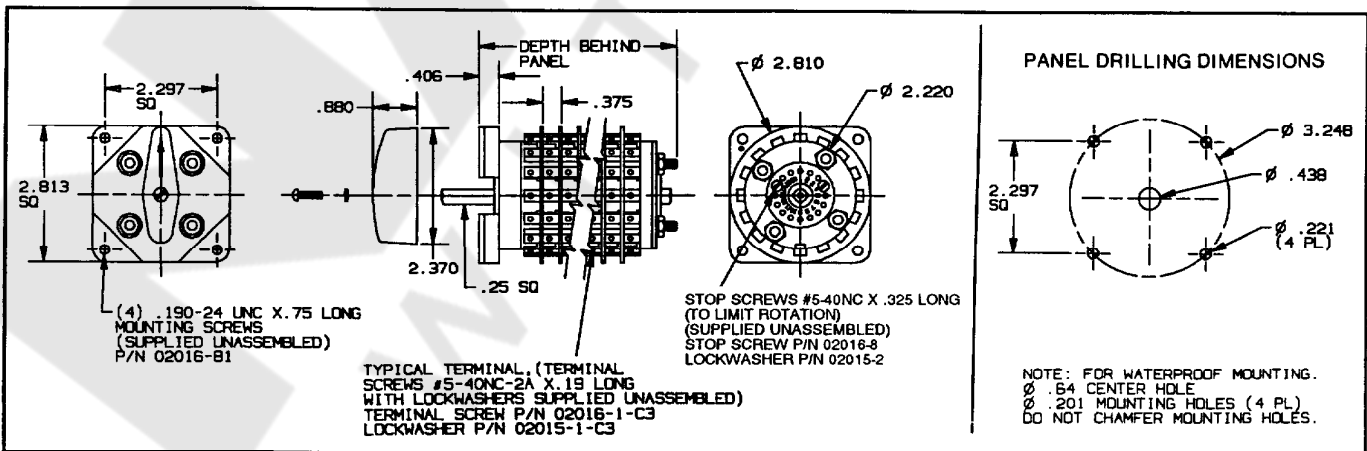

ELECTROSWITCH

UNIT OF ELECTRO SWITCH CORP. • Weymouth, Massachusetts 02188 • Telephone: (781) 335-5200 • FAX: (781) 335-4253

4-hole SERIES 31

- 2-8 POSITIONS
- 15A/600VAC CONTINUOUS

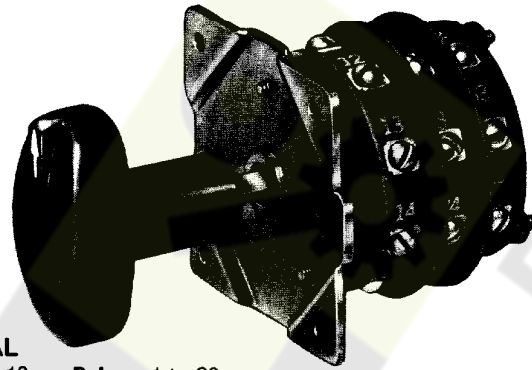

ELECTRICAL

Interrupting Ratings:

10A/125VAC, 60 to 400 cps, resistive to 0.75 pf
 5A/240VAC, 60 to 400 cps, resistive to 0.75 pf
 3A/600VAC, 60 to 400 cps, resistive to 0.75 pf
 5A/30VDC, resistive
 1A/125VDC, resistive

Overload: 50 operations @ 60A/125VAC, resistive

Voltage breakdown: 2200V rms minimum

Insulation resistance: 100 megohms minimum

Contact resistance: .01 ohms max.

Electrical life: See Page 3.

MECHANICAL

Sections: 1 to 10 **Poles:** 1 to 20

Positions: 8; adjustable stops for 2-8 position limited rotation

Contacts: break-before-make (non-shorting); make-before-break (shorting)

Action: 45° positive detent indexing

Mounting: panel, 4 tapped mounting holes

Panel thickness: 3/16 standard

Rotor contacts: silver plated phosphor-bronze, double-grip

Stationary contacts: silver plated copper, integral with screw-type terminals

Construction: contacts enclosed in molded-phenolic disks

Assemblage 2

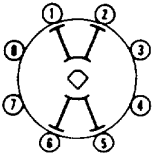

Assemblage 3

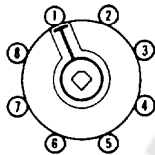

Nominal torques, weights, and depth behind panel are listed below.

assemblages are shown with handle in 0° position (12 o'clock)

No. Sec.	Catalog Number	No. Sec.	Catalog Number	Weight oz.	Torque lb.-in.	Depth behind Panel-inches
1	31201B	1	31301B	5	6	1.25
2	31202B	2	31302B	6	7	1.63
3	31203B	3	31303B	7	8	2.00
4	31204B	4	31304B	8	9	2.38
5	31205B	5	31305B	9	10	2.75
6	31206B	6	31306B	10	11	3.13
7	31207B	7	31307B	11	14	3.75
8	31208B	8	31308B	13	15	4.13
9	31209B	9	31309B	14	16	4.50
10	31210B	10	31310B	15	17	4.88

Features...



UL File No. E18174

Additional contact assemblages are available on request. See pages 4 & 5.

For make-before-break (shorting) contacts: add "S" (e.g. 31201B-S).

Nameplates are optional and are only supplied if requested at additional cost.

Not available with waterproof mounting

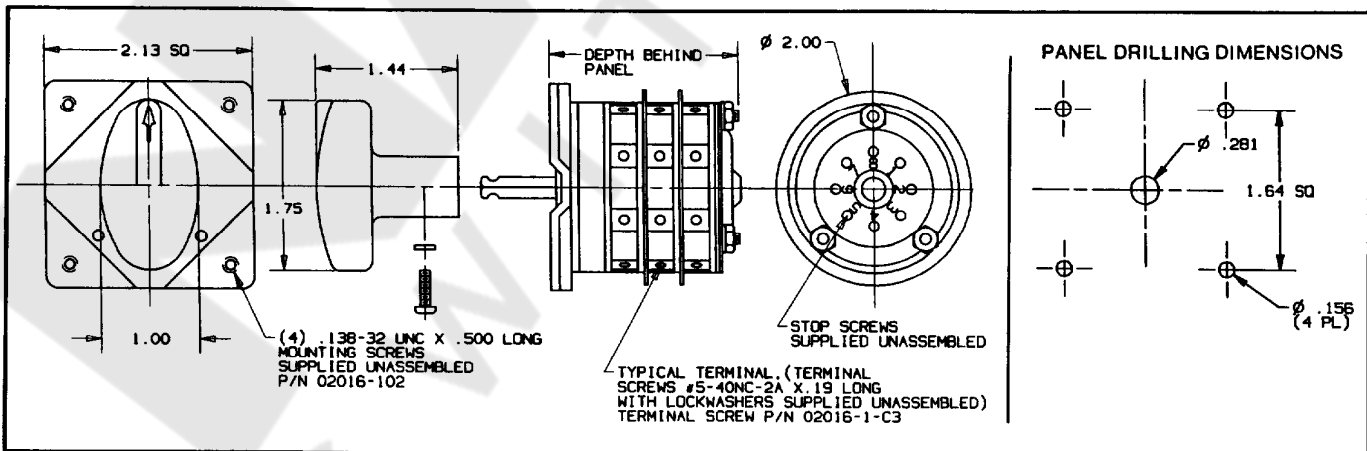

ELECTROSWITCH

UNIT OF ELECTRO SWITCH CORP. • Weymouth, Massachusetts 02188 • Telephone: (781) 335-5200 • FAX: (781) 335-4253

SERIES 31

- 2-8 POSITIONS
- 15A/600VAC CONTINUOUS



ELECTRICAL

Interrupting Ratings:

10A/125VAC, 60 to 400 cps, resistive to 0.75 pf
 5A/240VAC, 60 to 400 cps, resistive to 0.75 pf
 3A/600VAC, 60 to 400 cps, resistive to 0.75 pf
 5A/30VDC, resistive
 1A/125VDC, resistive

Overload: 50 operations @ 60A/125VAC, resistive

Voltage breakdown: 2200V rms minimum

Insulation resistance: 100 megohms minimum

Contact resistance: .01 ohms max.

Electrical life: See Page 3.

MECHANICAL

Sections: 1 to 10 **Poles:** 1 to 20

Positions: 8; adjustable stops for 2-8 position limited rotation

Contacts: break-before-make (non-shorting); make-before-break (shorting)

Action: 45° positive detent indexing

Mounting: panel, bushing-mount, single-hole

Panel thickness: 3/16 standard

Rotor contacts: silver plated phosphor-bronze, double-grip

Stationary contacts: silver plated copper, integral with screw-type terminals

Construction: contacts enclosed in molded-phenolic disks

Assemblage 2

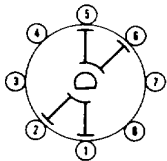

Assemblage 3

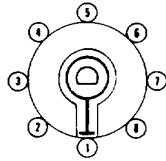

Nominal torques, weights, and depth behind panel are listed below.

assemblages are shown with handle in 0° position (12 o'clock)

No. Sec.	Catalog Number	No. Sec.	Catalog Number	Weight oz.	Torque lb.-in.	Depth behind Panel-inches	
						Assemblage 2	Assemblage 3 & 10
1	31201A	1	31301A	5	6	1.16	1.16
2	31202A	2	31302A	6	7	1.53	1.53
3	31203A	3	31303A	7	8	1.91	1.91
4	31204A	4	31304A	8	9	2.28	2.28
5	31205A	5	31305A	9	10	2.66	2.66
6	31206A	6	31306A	10	11	3.03	3.03
7	31207A	7	31307A	11	14	4.13	3.41
8	31208A	8	31308A	13	15	4.53	4.53
9	31209A	9	31309A	14	16	4.91	4.91
10	31210A	10	31310A	15	17	5.28	5.28

Features...



UL File No. E18174

Additional contact assemblages are available on request. See pages 4 & 5.

For make-before-break (shorting) contacts: add "S" (e.g. 31201A-S).

Nameplates are optional and are only supplied if requested at additional cost.

Contact factory if waterproof mounting is required.

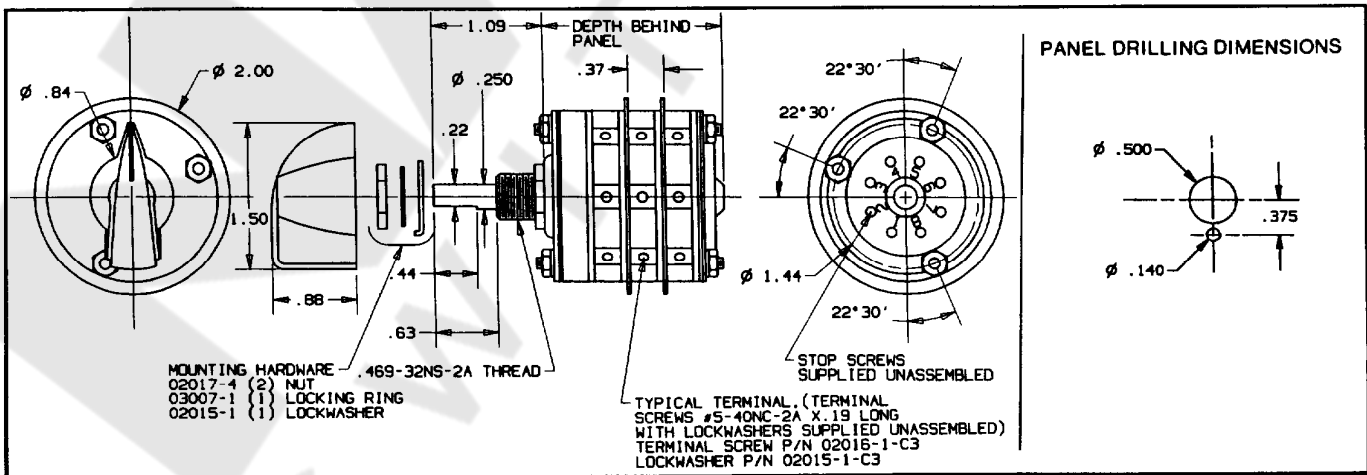

ELECTROSWITCH

UNIT OF ELECTRO SWITCH CORP. • Weymouth, Massachusetts 02188 • Telephone: (781) 335-5200 • FAX: (781) 335-4253

KEY-LOCK & KEY-OPERATED DETENT SWITCHES

To prevent unauthorized/accidental operation or alert operator to special switch functions:

KEY-LOCK HANDLE

- Key-lock units are locked in the vertical (12:00) position with key removable only when locked.
- All key-lock units have the same key-code.
- 4" square black nameplate
- Pistol-grip handle and Spring-return are available

KEY-OPERATED

- Key-operated units are available with key removable either in the vertical (12:00) position or all positions.
- Series 31 Key-operated switches are single-hole mount
- All key-operated units have the same key-code

Non-standard units are available with different key-codes. Other options are available on special request.

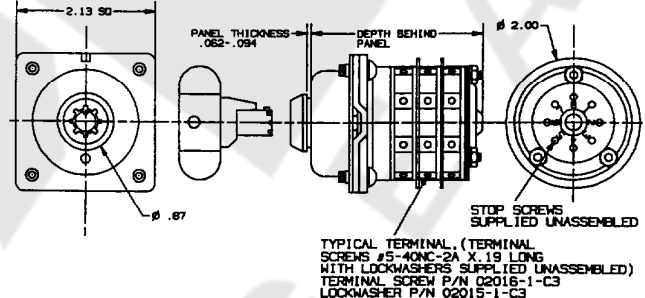
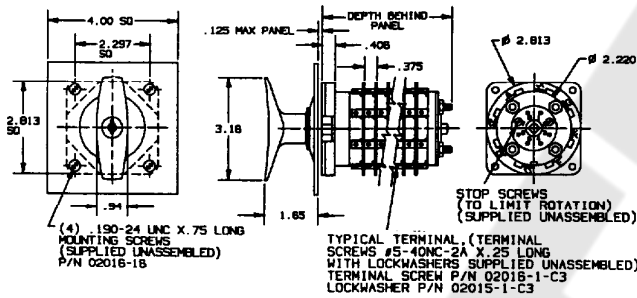

	POLES	DECKS	KEY-LOCK HANDLE			KEY-OPERATED			
			SERIES 21 45°	SERIES 25 30°	SERIES 28 22½°	SERIES 31 45°	SERIES 31 45°		
<p>SINGLE-THROW and DOUBLE-THROW applications</p> <p>The catalog numbers are for 2 or 3 position switches as shown and may be universally applied to any single-throw or double-throw application.</p> <p>The common positions are:</p> <p>single-throw double-throw</p>	2 poles per deck — series 21, 26, 31 3 poles per deck — series 25	1	61201B	62501B	63201B	65201A	65201B		
		2	61202B	62502B	63202B	65202A	65202B		
		3	61203B	62503B	63203B	65203A	65203B		
		4	61204B	62504B	63204B	65204A	65204B		
		5	61205B	62505B	63205B	65205A	65205B		
		6	61206B	62506B	63206B	65206A	65206B		
		7	61207B	62507B	63207B	Key Removable In Vertical Position	Key Removable in all Positions		
		8	61208B	62508B	63208B				
		9	61209B	62509B	63209B				
		10	61210B	62510B	63210B				
		15	61215B	62515B	63215B				
		20	61220B	62520B	—				
		25	61225B	62525B	—				
		<p>MULTI-POSITION TAP SWITCH</p> <p>The catalog numbers shown provide an OFF position and:</p> <p>1 - 7 taps (Series 21 & 31) 1 - 11 taps (Series 25) 1 - 15 taps (Series 28)</p> <p>The common positions are:</p>	1	1	61301B	62301B	63301B	65301A	65301B
				2	61302B	62302B	63302B	65302A	65302B
3	61303B			62303B	63303B	65303A	65303B		
4	61304B			62304B	63304B	65304A	65304B		
5	61305B			62305B	63305B	65305A	65305B		
6	61306B			62306B	63306B	65306A	65306B		
7	61307B			62307B	63307B				
8	61308B			62308B	63308B				
9	61309B			62309B	63309B				
10	61310B			62310B	63310B				
15	61315B	62315B	63315B						
20	61320B	62320B	—						
25	61325B	62325B	—						

SERIES 31 KEY-OPERATED PANEL DRILLING

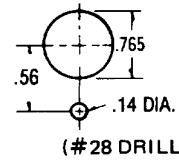

NOTE: For Series 24 part numbers for key-lock: Contact Factory



SOLENOID-LOCK and PUSH-TO-TURN DETENT SWITCHES

To prevent unauthorized/accidental operation or alert operator to special switch functions:

- Solenoid-lock switches shown below can be turned only when solenoid is energized (110-125VAC input).
- Contact Factory for part numbers for switches that can be turned when solenoid is de-energized.
- Push-to-turn units may be turned after a push of about 1/4 inch (15 lbs.) opens a NC contact (rated 10A/120VAC) allowing switching at no load or switching between positions without activating intermediate positions (wire in series with switch input).

SOLENOID-LOCK

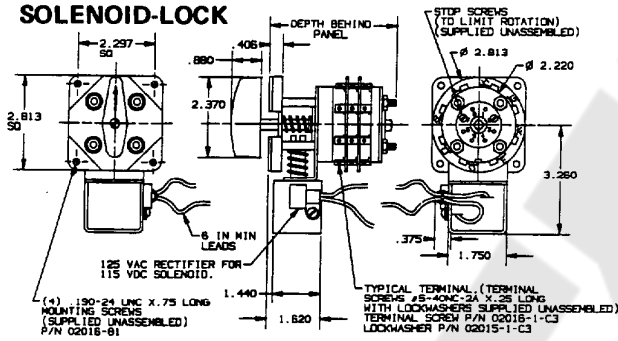

PUSH-TO-TURN

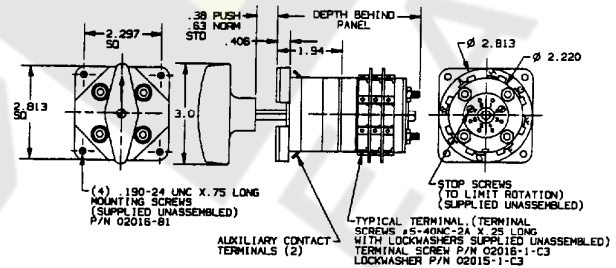

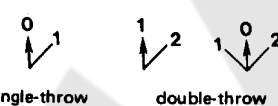
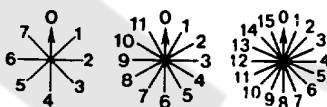
	POLES	DECKS	SOLENOID-LOCK			PUSH-TO-TURN		
			SERIES 21 45°	SERIES 25 30°	SERIES 28 22½°	SERIES 21 45°	SERIES 25 30°	SERIES 28 22½°
SINGLE-THROW and DOUBLE-THROW applications The catalog numbers are for 2 or 3 position switches as shown and may be universally applied to any single-throw or double-throw application. The common positions are: 	2 poles per deck - series 21, 28, 31 3 poles per deck - series 25	1	81201A	82501A	83201A	51201B	52501B	53201B
		2	81202A	82502A	83202A	51202B	52502B	53202B
		3	81203A	82503A	83203A	51203B	52503B	53203B
		4	81204A	82504A	83204A	51204B	52504B	53204B
		5	81205A	82505A	83205A	51205B	52505B	53205B
		6	81206A	82506A	83206A	51206B	52506B	53206B
		7	81207A	82507A	83207A	51207B	52507B	53207B
		8	81208A	82508A	83208A	51208B	52508B	53208B
		9	81209A	82509A	83209A	51209B	52509B	53209B
		10	81210A	82510A	83210A	51210B	52510B	53210B
		15	81215A	82515A	83215A	51215B	52515B	53215B
		20	81220B	82520B	-	51220B	52520B	-
25	81225B	82525B	-	51225B	52525B	-		
MULTI-POSITION TAP SWITCH The catalog numbers shown provide an OFF position and: 1 - 7 taps (Series 21 & 31) 1 - 11 taps (Series 25) 1 - 15 taps (Series 28) The common positions are: 	1 2 3 4 5 6 7 8 9 10 15 20 25	1	81301A	82301A	83301A	51301B	52301B	53301B
		2	81302A	82302A	83302A	51302B	52302B	53302B
		3	81303A	82303A	83303A	51303B	52303B	53303B
		4	81304A	82304A	83304A	51304B	52304B	53304B
		5	81305A	82305A	83305A	51305B	52305B	53305B
		6	81306A	82306A	83306A	51306B	52306B	53306B
		7	81307A	82307A	83307A	51307B	52307B	53307B
		8	81308A	82308A	83308A	51308B	52308B	53308B
		9	81309A	82309A	83309A	51309B	52309B	53309B
		10	81310A	82310A	83310A	51310B	52310B	53310B
		15	81315A	82315A	83315A	51315B	52315B	53315B
		20	81320B	82320B	-	51320B	52320B	-
25	81325B	82325B	-	51325B	52325B	-		

NOTE: For Series 24 part numbers for Solenoid-lock and Push-to-turn: Contact Factory.



UNIT OF ELECTRO SWITCH CORP. • Weymouth, Massachusetts 02188 • Telephone: (781) 335-5200 • FAX: (781) 335-4253

SPRING RETURN (MOMENTARY ACTION)

Catalog numbers for Series 21, 25, 28 and 31 single-hole mount designate switches supplied with flush handle. Catalog numbers for Series 24 and 31 4-hole mount switches are supplied with oval shank handle.

 Spring-return to center vertical.		Assemblage 2	Assemblage 3	Assemblage 5		
	Number Decks	Catalog Numbers	Catalog Numbers	Catalog Numbers	Weight	Depth behind Panel-inches
SERIES 21	1	71201A	71301A	—	1.1 LBS	2.00
	2	71202A	71302A	—	1.2 LBS	2.34
	3	71203A	71303A	—	1.3 LBS	2.72
SERIES 24	1	74201B	74301B	—	1.3 LBS	2.41
	2	74202B	74302B	—	1.5 LBS	2.78
	3	74203B	74303B	—	1.7 LBS	3.53
SERIES 25	1	72201A	72301A	72501A	1.1 LBS	2.00
	2	72202A	72302A	72502A	1.2 LBS	2.34
	3	72203A	72303A	72503A	1.3 LBS	2.72
SERIES 28	1	73201A	73301A	—	1.1 LBS	2.00
	2	73202A	73302A	—	1.2 LBS	2.34
	3	73203A	73303A	—	1.3 LBS	2.72
SERIES 31 Single-hole	1	75201A	75301A	—	6 OZ.	1.20
	2	75202A	75302A	—	7 OZ.	1.94
	3	75203A	75303A	—	8 OZ.	2.32
SERIES 31 4-hole	1	75201B	75301B	—	6 OZ.	1.25
	2	75202B	75302B	—	7 OZ.	2.09
	3	75203B	75303B	—	8 OZ.	2.50

Switches are supplied with hardware for limiting positions as desired.
Spring Return with waterproof mount is not recommended.

WATERPROOF MOUNT

To protect sealed panels from water leakage, the standard detent switches are provided with a rounded shaft, bushing and double-ribbed silicone rubber seal-nut for the shaft; and mounting screws with integral seal-rings to seal the mounting holes. Single-hole mount units use just the sealing-nut. Withstands 15 psi. Series 21, 24, 25 and 28 are for 1/16 inch panels. Series 31 is adjustable up to 3/16 inch panel. Waterproofing for thicker panels is also available on request.

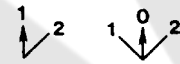
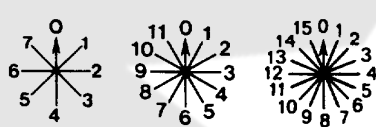
SINGLE-THROW and DOUBLE-THROW applications		2 poles per deck - series 21, 24, 28, 31 3 poles per deck - series 25	DECKS		SERIES 21	SERIES 24	SERIES 25	SERIES 28	SERIES 31
 single-throw	 double-throw		1	2	1	2	1	2	1
					41201A	44201B	45501A	48201A	
					41202A	44202B	45502A	48202A	
					41203A	44203B	45503A	48203A	
					41204A	44204B	45504A	48204A	
					41205A	44205B	45505A	48205A	
					41206A	44206B	45506A	48206A	
					41207A	44207B	45507A	48207A	
					41208A	44208B	45508A	48208A	
					41209A	44209B	45509A	48209A	
					41210A	44210B	45510A	48210A	
					41215A	—	45215A	48215A	
					41220B	—	45220B	—	
					41225B	—	45225B	—	
MULTI-POSITION TAP SWITCH					41301A	44301B	45301A	48301A	Use STANDARD TAP & SELECTOR SWITCHES on page 11 plus seal-nut #02017-8
					41302A	44302B	45302A	48302A	
					41303A	44303B	45303A	48303A	
					41304A	44304B	45304A	48304A	
					41305A	44305B	45305A	48305A	
					41306A	44306B	45306A	48306A	
					41307A	44307B	45307A	48307A	
					41308A	44308B	45308A	48308A	
					41309A	44309B	45309A	48309A	
					41310A	44310B	45310A	48310A	
					41315A	—	45315A	48315A	
					41320B	—	45320B	—	
					41325B	—	45325B	—	

NOTE: Switches are supplied with hardware for limiting positions as desired.
Contact factory for longer switches.



ELECTROSWITCH

UNIT OF ELECTRO SWITCH CORP. • Weymouth, Massachusetts 02188 • Telephone: (781) 335-5200 • FAX: (781) 335-4253

TYPICAL INSTRUMENT SWITCHES

SUPPLIED WITH ENGRAVED NAMEPLATES AND ASSEMBLED JUMPERS AS SHOWN

Catalog numbers shown in APPLICATION column are for series 24 & 31 with standard knurled handle except circuit 27 which is supplied with pistol-grip handle.

APPLICATION	ESCUTCHEON	"X" CHART & WIRING	DECK LAYOUT
VOLTMETER TRANSFER SWITCH CIRCUIT 04 3 ϕ , phase-to-phase Series Cat. No. 31 4-hole 3104C 24 2404C			
VOLTMETER TRANSFER SWITCH CIRCUIT 05 3 ϕ , phase-to-phase and phase-to-neutral Series Cat. No. 31 4-hole 3105C 24 2405C			
AMMETER TRANSFER SWITCH CIRCUIT 08 3 ϕ , 2 CT Series Cat. No. 31 4-hole 3108C 24 2408C			<p style="text-align: center;">make-before-break contacts</p>
AMMETER TRANSFER SWITCH CIRCUIT 10 3 ϕ , 3 CT Series Cat. No. 31 4-hole 3110C 24 2410C			<p style="text-align: center;">make-before-break contacts</p>
AMMETER VOLTMETER TRANSFER SWITCH CIRCUIT 15 3 ϕ , 3 CT volts-phase-to-phase amps-phase Series Cat. No. 31 4-hole 3115C 24 2415C			<p style="text-align: center;">Deck 3 & 4 make-before-break contacts</p>
MOTOR CONTROL SWITCH CIRCUIT 27 Split-Field Motor Series Cat. No. 31 4-hole 3127D 24 2427D			

NOTE: This circuit is supplied with pistol-grip handle, standard.



ELECTROSWITCH

UNIT OF ELECTRO SWITCH CORP. • Weymouth, Massachusetts 02188 • Telephone: (781) 335-5200 • FAX: (781) 335-4253

HANDLES

SERIES 21, 25, 28

Handle "A" is standard for Series 21, 25 and 28. For Series 21 and 25 switches with 15 or more decks, use "B" handle as standard.

ALL HANDLES IN THIS ROW ARE INTERCHANGEABLE

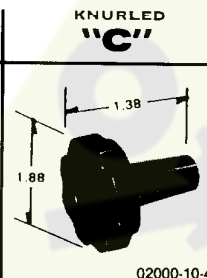
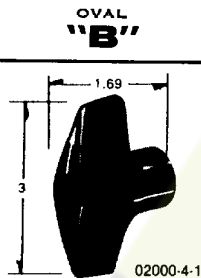
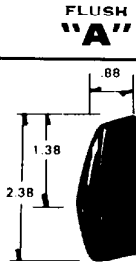

SERIES 24

Handle "B" is standard.

ALL HANDLES IN THIS ROW ARE INTERCHANGEABLE

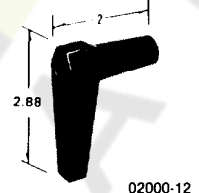
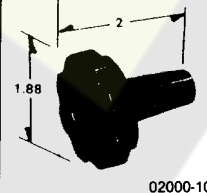
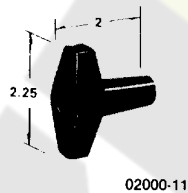

SERIES 31

Handle "A" is standard for 31 single hole mount. Handle "B" is standard for 31 4-hole mount.

NOTE: B, C & D Handles require special shaft for single hole mounted switches.

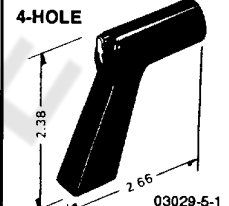
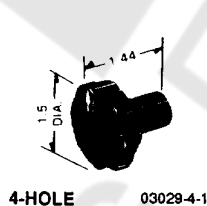
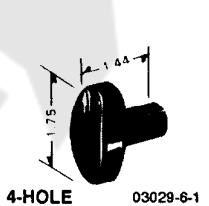
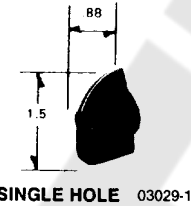

NAMEPLATES

- Nameplates are optional and are only supplied if requested at additional cost, except Series 24, see page 7.
- Black phenolic nameplates with white characters engraved to your specifications.
- Plates are secured to panel by the switch-mounting screws.
- NOTE: No nameplate available for Series 31 Key-operated.

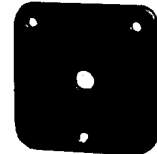
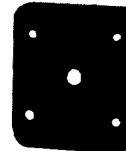
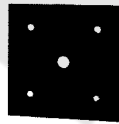

Series	21, 25, 28	31-Single Hole Mount	31-4 Hole Mount	24
Code Number	08	30	31	10
Size	4" x 4"	2" diameter	2.38" x 2.88"	2.81" x 2.90"
Title Engraving	15	10	12	14
Position Engraving	8	6	6	5
	For Waterproof Mount use Code No. 09	Use Hex seal nut No. 02017-8 for Waterproof Mount	Waterproof Mount not available	For Waterproof Mount Use Code No. 11

JUMPERS

	Series 21	Series 25	Series 28	Series 31 single-hole	Series 31 4-hole	Series 24
Adjacent Contact Same Deck	02011-2-C3	02011-1-C3	02011-3-C3	03057-1-C3	03057-1-C3	02011-10-C3
Adjacent Deck Same Contact	02011-4-C3	02011-4-C3	02011-4-C3	03059-1-C3	03059-1-C3	02011-12-C3
2" wire & lugs	00314-1	00314-1	00314-1	00314-1	00314-1	002012-1
3.4" wire & lugs	00314-3	00314-3	00314-3	00314-3	00314-3	002012-2
5.3" wire & lugs	00314-4	00314-4	00314-4	00314-4	00314-4	002012-3

- Series 21, 25, 28 & 31 use 14 gauge wire in wire & lug jumpers.
- Series 24 switches use 10 gauge wire in wire & lug jumpers.
- Strap Jumpers: Silver plated brass.

Wire & Lug Jumpers

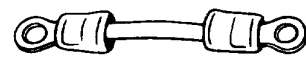

Wire jumpers are ordered individually.

Strap Jumpers



Metal jumpers are supplied in packages of 10 and 25.







UNIT OF ELECTRO SWITCH CORP. • Weymouth, Massachusetts 02188 • Telephone: (781) 335-5200 • FAX: (781) 335-4253

SNAP-ACTION SWITCHES

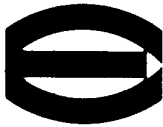
Basic Specifications

ELECTRO Snap-Action Switches

 CHARACTERISTICS	SNAP ACTION SWITCHES			
	SERIES 101 	SERIES 103 	SERIES 105 	SERIES 107 
SECTIONS	1-12	1-12	1-8	1-8
POLES	1-12	1-12	1-8	1-8
POSITIONS	2-4	2-4	2-4	2-4
DETENTING ANGLE	90°	90°	90°	90°
ELECTRICAL RATINGS				
Continuous Rating	20A-600V	45A-600V	75A-600V	200A-600V
Interrupting Current				
120 VAC	15A	40A	60A	200A
240 VAC	10A	40A	60A	200A
600 VAC	7.5A*	30A	60A	200A
24 VDC	15A	30A	60A	200A
125 VDC	10A	30A	60A	on request
250 VDC	5A	30A	60A	on request
Max. Breaking Ability	90A	180A	360A	600A
Max. Making Ability	90A	180A	360A	600A
Momentary Current				
3 seconds	140A	300A	300A	
30 seconds	45A	125A	250A	
60 seconds	35A	100A	175A	
Overload Current (50 operations) 120 VAC	90A	180A	360A	600A
Dielectric Strength	2200 VRMS	2200 VRMS	2200 VRMS	2200 VRMS
Insulation Resistance	100 megohms	100 megohms	100 megohms	100 megohms
Contact Resistance	30 milliohms	10 milliohms	6 milliohms	1.5 milliohms
HORSEPOWER RATINGS				
3-phase ratings - reduce by half for 1-phase				
110/120 VAC	½ hp			
220/240 VAC	½ hp	2 hp		
440/480 VAC		2 hp		
MOUNTINGS				
Single-Hole	Yes			
4-Hole	Yes	Yes	Yes	Yes
Base-mount	Yes	Yes	Yes	Yes
Water proof-mount	Yes	Yes	Yes	Yes
SPECIAL DRIVES				
Spring return	Yes	Yes		
APPROVALS				
UL Recognized	Yes	Yes		
CSA Certified	Yes	Yes		

*CKT 1,2,3,4

are heavy-duty, two- to four-position, snap-action, rotary switches that enable numerous power circuits to be operated simultaneously by a single handle. Positive, double-wiping contacts are driven by a powerful, coil-spring mechanism to make and break as much as 200 amperes at 600 volts a-c. The largest of these switches requires panel-space less than 10 x 10 inches.

Features

- Two to four positions and up to 12 poles
- Time proven double wiping contacts for low contact resistance even under extreme shock and vibration conditions
- Current ratings up to 200 amperes at 600 VAC
- Switching speed not dependant on operator action
- Quick make and break action. Approximately ten millisecond contact transfer time
- Excellent for DC as well as AC switching
- All making and breaking of contacts takes place in the fully enclosed decks
- Versatile-many special designs are available to fit every application
- Available in MIL SPEC versions. Contact factory or your local representative
- Insulating materials - NEMA Class A (105°C)



ELECTROSWITCH

UNIT OF ELECTRO SWITCH CORP. • Weymouth, Massachusetts 02188 • Telephone: (781) 335-5200 • FAX: (781) 335-4253

SNAP-ACTION SWITCHES

Details of Construction

Standard components for Snap-Action switches are shown on this page, with the symbols that represent them in wiring diagrams.

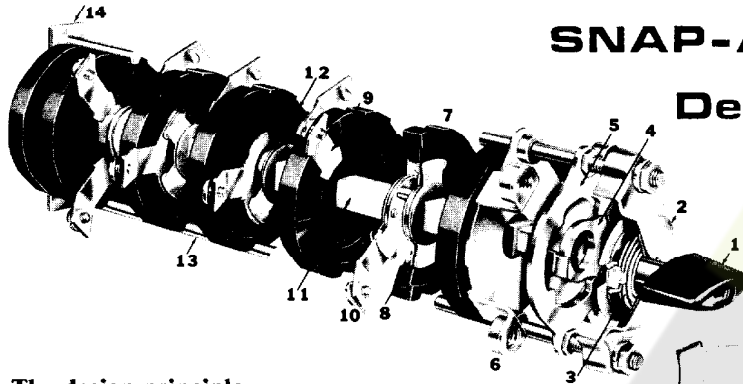

The design principle

that enables us to combine a relatively small number of basic parts to satisfy a wide variety of requirements for selector and control switching in power circuits is shown by this exploded view. Standard switches built on this principle, in 15-40-60-, and 200-ampere capacity, are listed in this section. The catalogued units merely indicate switching possibilities; we will gladly recommend other combinations, based on our experience, for specific requirements.

The electrical system

of the Series 100 switch comprises two or more stationary contacts (9) and one or more sets of movable contacts. These are pairs of spring-metal blades (8) that make high-pressure, low-resistance contact on both faces of the stationary contacts while bridging two or more of these contacts. The stationary contacts fit in radial grooves (12) in the rim of molded insulating disks (7) within which the movable contacts are carried on an insulated shaft (11). All making and breaking of electric circuits takes place within the closed spaces between adjacent disks. Their quick-break action makes these switches particularly suitable for direct-current service. The ends of the stationary contacts extend outside the insulating disks and serve as connecting terminals (10). This one-piece contact/terminal construction minimizes series resistance and heating. Depending on current rating and on wiring requirements, the terminals may have tapped holes for connecting-screws or clearance holes for bolt-connection of cable-lugs.

The mechanical system

of the Series 100 Switch is designed to provide uniform high-speed make and break, regardless of whether the operating handle (1) is turned rapidly or slowly. Turning the handle through about 120° in either direction winds a powerful coil spring (3). When this is fully wound, the indexing plate (4) is momentarily withdrawn from the locking plate (5) by an eccentric cam. The drive-shaft and movable contacts then snap rapidly to the next position, where the indexing plate holds them until the spring-drive mechanism is again operated. Transit time is about ten milliseconds.

Assembly

The snap-drive mechanism, mechanism-cover (2), locking plate, mounting bracket (6), insulating disks, and back plate (14) are stacked on side securing rods (13) and bolted firmly together to form a rigid assembly. The handle is keyed to the operating shaft and secured by a screw.

STATIONARY CONTACTS



Non-shorting (break-before-make) contacts are standard in all the ratings and circuits shown in this section.



Shorting (make-before-break) contacts, required in some special circuits, are available on order.



The "Sweep" contact maintains the connection with the rotor through consecutive positions.

MOVABLE CONTACTS (rotors)

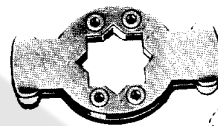

The simple, straight-across rotor bridges stationary contacts in the same insulating disk. It provides single-throw switching in Circuit 1 and double-throw switching in Circuit 6 (see page 21).



The right-angle-blade rotor provides a double-throw switching, with an intermediate OFF position, in Circuit 7. (See page 21).

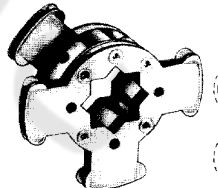

A multi-fingered blade is combined with a single-contact blade to form a composite (double-deck) rotor that interconnects stationary contacts in adjacent disks. Suitable blade arrangements provide double-throw, triple-throw, or four-throw switching. (See page 21).

INSULATING DISCS (and circuits)

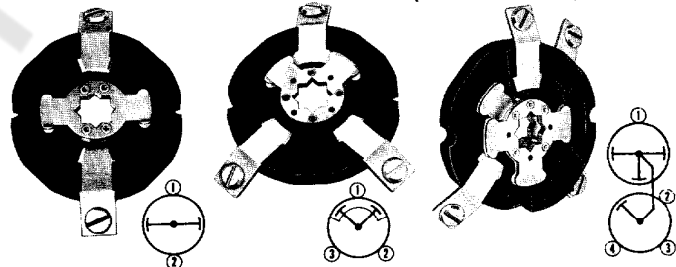

The insulating disks, molded of phenolic per MIL-M-14, have three functions. They hold the stationary contacts; they form enclosures that contain all making and breaking contacts; and they provide both mechanical and electrical separation of switching sections. Typical circuits with corresponding schematic diagrams, are shown above.



UNIT OF ELECTRO SWITCH CORP. • Weymouth, Massachusetts 02188 • Telephone: (781) 335-5200 • FAX: (781) 335-4253

ALL ABOUT TESTING OF SNAP-ACTION SWITCHES

There are many ways to test switches. We use a combination of tests to provide meaningful data for all applications. These include:

1. Cycle it mechanically until it breaks. This is usually an academic test since switches that do not switch electric power are not needed. An exception is a set-up switch whereby the switch sets up a complicated circuit and then a circuit breaker switches the power. All our testing is done under electrical load.
2. Test under an application oriented specification - something that simulates actual operating conditions including environment, overloads, surges, etc. UL1054 on SPECIAL USE SWITCHES and CSA C22.2 on INDUSTRIAL CONTROL EQUIPMENT for use in Ordinary (non-hazardous) Locations are probably the best specifications in widespread use. The series 101 and 103 are UL recognized and CSA certified to these specifications.
3. Test at different ratings until destruction to determine ultimate life (destruction could be mechanical failure, shorting out, dielectric failure, excessive heat rise, etc.) The test conditions are outlined on the SELECTOR CHART on page 18. The results are summarized below:

Both UL and CSA testing consists of two parts:

1. Product testing to the specifications.
2. Follow-up service by UL and CSA personnel at the factory, including inspection and testing to insure that the quality and reliability is maintained.

If all conditions are met, the switches are considered "certified electrical equipment" by CSA and "recognized components" by UL and the applications are subject to review by these agencies to assure suitability.

UL AND CSA RATINGS

	UL Recognized	CSA Certified
Series 101	15A-120 VAC	15A-120 VAC
	10A-240 VAC	10A-240 VAC
	*7.5A-600 VAC	5A-480 VAC
	10A-125 VDC	3A-600 VAC
	5A-250 VDC	10A-125 VDC
	1/2HP-120/240 VAC	5A-250 VDC
	*CKT 1,2,3,4	1/2HP-120/240 VAC
Series 103	30A-480 VAC	30A-600 VAC
	30A-250 VDC	30A-250 VDC
	2HP-240/480 VAC	2HP-240/480 VAC

These recognized or certified ratings are not necessarily the limits of switch capacity. They represent the acceptable tested ratings to comply with individual standards.

Tests include:

1. Overload -- 50 cycles of operation.
 - a. general -- 125% rating (UL)
 - b. Horsepower - 6 times full load current at .4 to .5 pf
2. Endurance -- 6000 operations (DC resistive; AC at .75 to .80 pf)
3. Temperature rise of contacts - 30° max. at maximum continuous current rating
4. Dielectric Voltage Withstand - 2200VRMS
5. Spacings (between live parts or live parts to ground)
 - UL - 0-250V (3/64 in. min.). 251-600V (1/8 in. min.)

CSA	through air	over surface
51-150V	.12 inches	.25 inches
151-300V	.25	.37
301-600V	.37	.50

LIFE EXPECTANCY under ELECTRICAL LOAD – make and break operations.

These tables show the results of life-tests performed in our standardization laboratory under a variety of service conditions.

Switch Series	ALTERNATING CURRENT — 60 Hz					DIRECT CURRENT					
	Amps.	Throws	Inductive ¹ , resistive, or lamp load			24 volts		125 volts		250 volts	
			125 volts	250 volts	600 volts	Resistive ²	Inductive ³	Resistive ²	Inductive ³	Resistive ²	Inductive ³
101 20 amperes 600 volts continuous	3	1	55,000	45,000	35,000	55,000	40,000	45,000	30,000	25,000	20,000
		2-3-4	50,000	40,000	30,000	50,000	35,000	40,000	25,000	20,000	15,000
	5	1	45,000	35,000	25,000	45,000	30,000	35,000	20,000	20,000	15,000
		2-3-4	40,000	30,000	20,000	40,000	25,000	30,000	15,000	15,000	10,000
10	1	35,000	25,000	15,000	35,000	15,000	20,000	10,000	—	—	
	2-3-4	30,000	15,000	—	30,000	10,000	15,000	5,000	—	—	
15	1	20,000	10,000	—	20,000	—	—	—	—	—	
	2-3-4	10,000	—	—	10,000	—	—	—	—	—	
103 45 amperes 600 volts continuous	15	1	35,000	35,000	35,000	35,000	35,000	35,000	35,000	30,000	—
		2-3-4	35,000	35,000	35,000	35,000	35,000	35,000	35,000	25,000	—
	30	1	35,000	33,000	30,000	35,000	—	30,000	—	—	—
		2-3-4	30,000	25,000	20,000	30,000	—	25,000	—	—	—
40	1	30,000	28,000	25,000	30,000	—	25,000	—	—	—	
	2-3-4	25,000	20,000	15,000	25,000	—	20,000	—	—	—	
105	60	1	7,500	7,000	6,500	7,500	—	5,000	—	4,000	—
		2-3-4	7,000	6,500	6,000	7,000	—	4,000	—	3,000	—
75	1	4,000	3,500	3,000	4,000	—	—	—	—	—	
	2-3-4	3,500	3,000	—	2,000	—	—	—	—	—	
107	200	1	7,500	7,000	6,500	7,000	—	—	—	—	—
		2-3-4	7,000	6,500	6,000	6,500	—	—	—	—	—

¹ 0.8 pf

² and lamp load

³ 0.08 henry



UNIT OF ELECTRO SWITCH CORP. • Weymouth, Massachusetts 02188 • Telephone: (781) 335-5200 • FAX: (781) 335-4253

HOW TO ORDER Snap-Action Switches

Choose (from pages 22 through 29) the switch part number that has the desired circuit arrangement, number of poles, and number of positions.

This should be a complete switch number such as 101605A-2A.

When the application requires a switch not shown in this catalog; complete the Application Worksheet on page 31 and forward to the factory.

Nameplates are optional.

Standard switches are supplied with Type A handles. These are not interchangeable with B, C or D handles.

BASIC NUMBERING SYSTEM SNAP-ACTION SWITCHES

STANDARD SWITCHES

101 3 05 A - 3 S

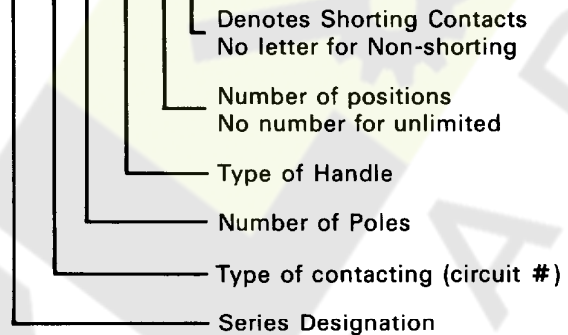

NON-STANDARD SWITCHES

101 9 05 LA

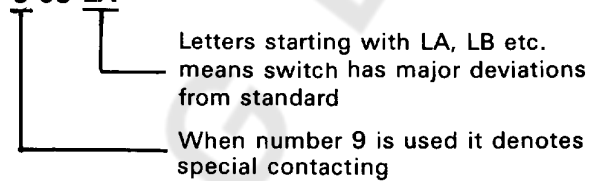

For part numbers of special switch configurations, consult factory or your local technical representative.

Contact Diagrams

CIRCUIT NO. 1

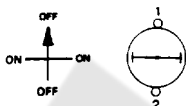

POLE	DECK	CONTACTS		POSITIONS			
		HANDLE	END	1	2	3	4
1	1	1	2		X		X

CIRCUIT NO. 4

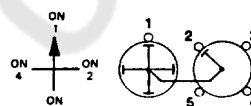

POLE	DECK	CONTACTS		POSITIONS			
		HANDLE	END	1	2	3	4
1	2	1	2		X		
1	2	3	4			X	
1	2	5	4				X

CIRCUIT NO. 2

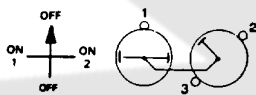

POLE	DECK	CONTACTS		POSITIONS			
		HANDLE	END	1	2	3	4
1	2	1	2		X		
1	2	3	4				X

CIRCUIT NO. 6

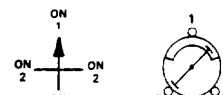

POLE	DECK	CONTACTS		POSITIONS			
		HANDLE	END	1	2	3	4
1	1	1	2		X		X
1	1	3	4		X		X

CIRCUIT NO. 3

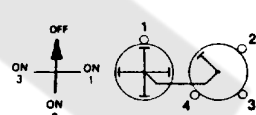

POLE	DECK	CONTACTS		POSITIONS			
		HANDLE	END	1	2	3	4
1	2	1	2		X		
1	2	3	4			X	
1	2	5	4				X

CIRCUIT NO. 7

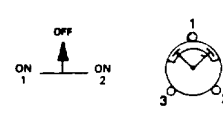

POLE	DECK	CONTACTS		POSITIONS		
		HANDLE	END	1	2	3
1	1	1	2			X
1	1	3	4		X	



ELECTROSWITCH

UNIT OF ELECTRO SWITCH CORP. • Weymouth, Massachusetts 02188 • Telephone: (781) 335-5200 • FAX: (781) 335-4253

SERIES 101

- 2-4 POSITIONS
- 20A/600VAC CONTINUOUS



ELECTRICAL

Interrupting Ratings:

- 15A/120VAC (60 to 400 cps 0.8 pf)
- 10A/240VAC (60 to 400 cps 0.8 pf)
- 7.5A/600VAC CKT 1,2,3,4 (60 to 400 cps 0.8 pf)
- 10A/125VDC resistive load
- 1/2hp - 200/240VAC

Overload: 50 operations @ 90A/600VAC resistive

Dielectric breakdown: 2200V rms minimum

Insulation resistance: 100 megohms minimum

Contact resistance: 30 milliohms max.
(10 milliohms average before life)

MECHANICAL

Poles: 1 to 12 depending on circuits **Positions:** 2, 3 or 4

Contacts: break-before-make (non-shorting); make-before-break (shorting)

Action: positive snap action. 90° indexing

Movement: unlimited continuous rotation in both directions or
factory limited to two or three positions

Mounting: panel-mount, four tapped mounting holes

Panel thickness: 3/16 standard

Rotor contacts: phosphor-bronze, double-grip

Stationary contacts: copper, integral with screw-type terminals

Construction: contacts enclosed in molded-phenolic disks

No. Poles	Catalog Number	Catalog Number	Catalog Number	Catalog Number	Catalog Number	Catalog Number	Catalog Number	Weight oz.	Torque lb-in		Depth behind Panel	
									Cir. 1	6-7	Cir. 1	6-7
1	101101A	101101A-2	101101A-2A	101601A	101601A-2	101601A-2A	101701A-3	4	4	4	1.28"	1.28"
2	101102A	101102A-2	101102A-2A	101602A	101602A-2	101602A-2A	101702A-3	5	4	4	1.53	1.53
3	101103A	101103A-2	101103A-2A	101603A	101603A-2	101603A-2A	101703A-3	6	4	4	1.78	1.78
4	101104A	101104A-2	101104A-2A	101604A	101604A-2	101604A-2A	101704A-3	7	4	4	2.03	2.03
5	101105A	101105A-2	101105A-2A	101605A	101605A-2	101605A-2A	101705A-3	8	4	4	2.28	2.28
6	101106A	101106A-2	101106A-2A	101606A	101606A-2	101606A-2A	101706A-3	9	4	4	2.53	2.53
7	101107A	101107A-2	101107A-2A	101607A	101607A-2	101607A-2A	101707A-3	10	4	8	2.78	3.00
8	101108A	101108A-2	101108A-2A	101608A	101608A-2	101608A-2A	101708A-3	11	4	8	3.03	3.16
9	101109A	101109A-2	101109A-2A	101609A	101609A-2	101609A-2A	101709A-3	12	8	8	3.41	3.41
10	101110A	101110A-2	101110A-2A	101610A	101610A-2	101610A-2A	101710A-3	13	8	8	3.66	3.66
11	101111A	101111A-2	101111A-2A	101611A	101611A-2	101611A-2A	101711A-3	14	8	8	3.91	3.91
12	101112A	101112A-2	101112A-2A	-	-	-	-	15	8	-	4.16	-

Handle and terminal positions are viewed from front of panel (handle-end of switch). Terminal locations shown are for single-pole switches.

Torques, weights and depth behind panel in these tables are nominal.

No. Poles	Catalog Number	No. Poles	Catalog Number	No. Poles	Catalog Number	No. Poles	Catalog Number	Weight oz.	Torque lb.-in.		Depth behind Panel	
									Cir. 2-3-4	Cir. 2-3-4		
1	101201A	1	101201A-3	1	101301A	1	101301A-3	6	4	4	1.53"	
2	101202A	2	101202A-3	2	101302A	2	101302A-3	7	4	4	2.03	
3	101203A	3	101203A-3	3	101303A	3	101303A-3	9	4	4	2.53	
4	101204A	4	101204A-3	4	101304A	4	101304A-3	10	4	4	3.03	
5	101205A	5	101205A-3	5	101305A	5	101305A-3	12	4	4	3.53	
6	101206A	6	101206A-3	6	101306A	6	101306A-3	14	4	4	4.03	
7	101207A	7	101207A-3	7	101307A	7	101307A-3	16	8	8	4.65	
8	101208A	8	101208A-3	8	101308A	8	101308A-3	18	8	8	5.16	

†Location of rotor blade for switch with 3 ON positions



UNIT OF ELECTRO SWITCH CORP. • Weymouth, Massachusetts 02188 • Telephone: (781) 335-5200 • FAX: (781) 335-4253

**SERIES 101
Features...**



UL File No. E18174

The flush handle with arrow is standard.

For make-before-break (shorting) contacts:
add "S" (e.g. 101102A-S).

Nameplates are optional and only supplied if
requested at additional cost.

Available Options Include:

- Spring Return
- Waterproof Mountings
- Quick-Connect Terminals

NAMEPLATES

Plates are secured to the panel by
the switch-mounting hardware.

LOCATION OF
TITLE ENGRAVING

TYPICAL LOCATION OF
POSITION ENGRAVING

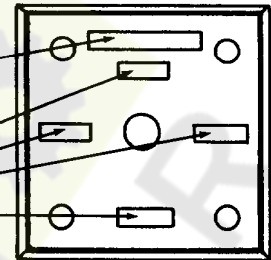

Color: Black

Code:	04
Size:	2-3/8 x 2-7/8 1/16 thick
* Title Engraving:	12 Characters
* Position Engraving	6 Characters
Letter Size:	5/32" White Letters

* Maximum recommended characters
(including spaces)

JUMPERS Ordered individually

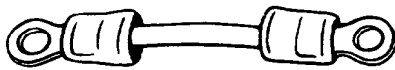

- | | |
|------------------|----------|
| 2.1" wire & lugs | 002012-5 |
| 2.5" wire & lugs | 002012-6 |
| 3.8" wire & lugs | 002012-7 |

HANDLES

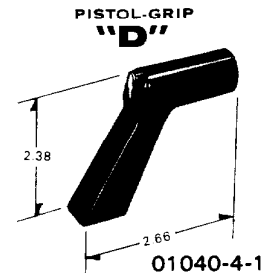
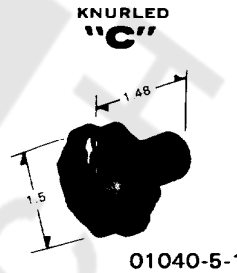
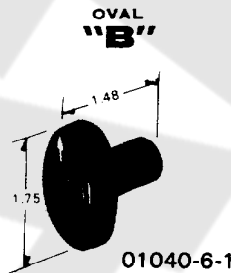
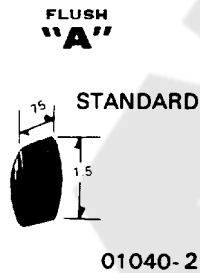

NOTE: Type "A" handle is NOT interchangeable with types "B", "C", "D".

MOUNTING SCREW
P/N 02016-103

All dimensions in inches

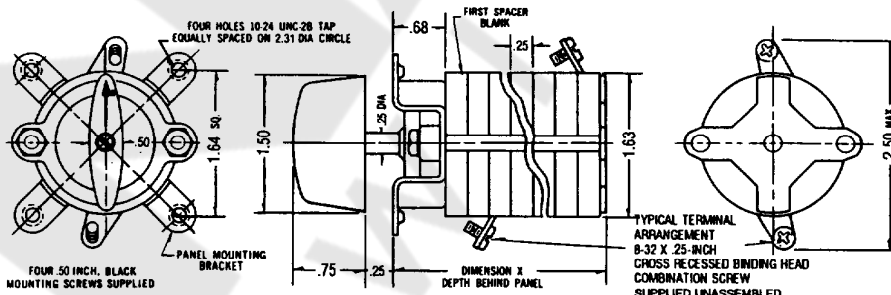

PANEL DRILLING DIMENSIONS

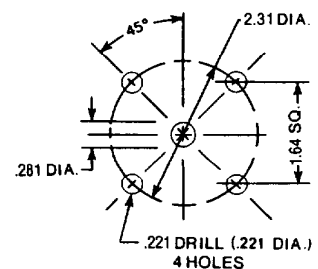

NOTE: FOR WATERPROOF MOUNTINGS:
THE (4) MOUNTING HOLES S/B .201" DIA.
THE CENTER HOLE S/B .5" DIA.
DO NOT CHAMFER MOUNTING HOLES
1/64 MAX. BREAK PERMISSIBLE



UNIT OF ELECTRO SWITCH CORP. • Weymouth, Massachusetts 02188 • Telephone: (781) 335-5200 • FAX: (781) 335-4253

SERIES 103

- 2-4 POSITIONS
- 45A/600VAC CONTINUOUS

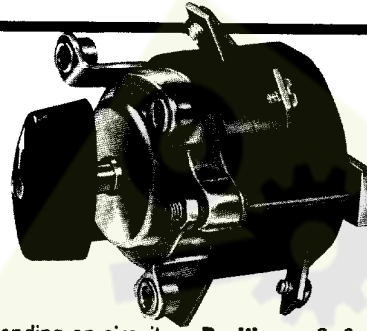

ELECTRICAL

Interrupting Ratings:

- 30A/480VAC (60 to 400 cps 0.8 pf)
- 30A/250VDC resistive load
- 2 hp - 440/480VAC

Overload: 50 operations @ 180A/600VAC resistive

Dielectric breakdown: 2200V rms minimum

Insulation resistance: 100 megohms minimum

Contact resistance: 10 milliohms max. (4 milliohms average before life)

MECHANICAL

Poles: 1 to 12 depending on circuits **Positions:** 2, 3 or 4

Contacts: break-before-make (non-shorting); make-before-break (shorting)

Action: positive snap action. 90° indexing

Movement: unlimited continuous rotation in both directions or factory limited to two or three positions

Mounting: panel-mount, four tapped mounting holes

Panel thickness: 3/16 standard

Rotor contacts: phosphor-bronze, double-grip

Stationary contacts: copper, integral with screw-type terminals

Construction: contacts enclosed in molded-phenolic disks

No. Poles	Catalog Number	Catalog Number	Catalog Number	Catalog Number	Catalog Number	Catalog Number	Catalog Number	Weight lbs		Torque lb-in		Depth behind Panel	
								Cir 1	6-7	Cir 1	6-7	Cir. 1	6-7
1	103101A	103101A-2	103101A-2A	103601A	103601A-2	103601A-2A	103701A-3	1.0	1.0	9	9	1.84"	1.84"
2	103102A	103102A-2	103102A-2A	103602A	103602A-2	103602A-2A	103702A-3	1.2	1.2	9	9	2.22	2.22
3	103103A	103103A-2	103103A-2A	103603A	103603A-2	103603A-2A	103703A-3	1.4	1.4	9	9	2.59	2.59
4	103104A	103104A-2	103104A-2A	103604A	103604A-2	103604A-2A	103704A-3	1.6	1.6	9	9	2.97	2.97
5	103105A	103105A-2	103105A-2A	103605A	103605A-2	103605A-2A	103705A-3	1.8	1.8	9	9	3.34	3.34
6	103106A	103106A-2	103106A-2A	103606A	103606A-2	103606A-2A	103706A-3	2.0	2.0	9	9	3.72	3.72
7	103107A	103107A-2	103107A-2A	103607A	103607A-2	103607A-2A	103707A-3	2.2	2.4	9	18	4.09	4.31
8	103108A	103108A-A	103108A-2A	103608A	103608A-2	103608A-2A	103708A-3	2.4	2.6	9	18	4.47	4.69
9	103109A	103109A-2	103109A-2A	103609A	103609A-2	103609A-2A	103709A-3	2.8	2.8	18	18	5.06	5.06
10	103110A	103110A-2	103110A-2A	103610A	103610A-2	103610A-2A	103710A-3	3.0	3.0	18	18	5.44	5.44
11	103111A	103111A-2	103111A-2A	103611A	103611A-2	103611A-2A	103711A-3	3.2	3.2	18	18	5.81	5.81
12	103112A	103112A-2	103112A-2A					3.4		18		6.19	

Handle and terminal positions are viewed from front of panel (handle-end of switch). Terminal locations shown are for single-pole switches.

Torques, weights and depth behind panel in these tables are nominal.

No. Poles	Catalog Number	No. Poles	Catalog Number	No. Poles	Catalog Number	No. Poles	Catalog Number	No. Poles	Catalog Number	Weight lbs.	Torque lb.-in.	Depth behind Panel	
												Cir. 2-3-4	
1	103201A	1	103201A-3	1	103301A	1	103301A-3	1	103401A	1.2	9	2.22"	
2	103202A	2	103202A-3	2	103302A	2	103302A-3	2	103402A	1.6	9	2.97	
3	103203A	3	103203A-3	3	103303A	3	103303A-3	3	103403A	2	9	3.72	
4	103204A	4	103204A-3	4	103304A	4	103304A-3	4	103404A	2.4	9	4.47	
5	103205A	5	103205A-3	5	103305A	5	103305A-3	5	103405A	2.8	12	5.22	
6	103206A	6	103206A-3	6	103306A	6	103306A-3	6	103406A	3.2	12	5.97	
7	103207A	7	103207A-3	7	103307A	7	103307A-3	7	103407A	3.7	18	6.94	
8	103208A	8	103208A-3	8	103308A	8	103308A-3	8	103408A	4.1	18	7.69	

Location of rotor blade for switch with 3 ON positions



UNIT OF ELECTRO SWITCH CORP. • Weymouth, Massachusetts 02188 • Telephone: (781) 335-5200 • FAX: (781) 335-4253

**SERIES 103
Features...**



UL File No. E18174

The flush handle with arrow is standard.

For make-before-break (shorting) contacts:
add "S" (e.g. 103102A-S).

Nameplates are optional and only supplied if
requested at additional cost.

Available Options Include:

- Spring Return
- Waterproof Mountings

NAMEPLATES

Plates are secured to the panel by
the switch-mounting hardware.

LOCATION OF
TITLE ENGRAVING

TYPICAL LOCATION OF
POSITION ENGRAVING

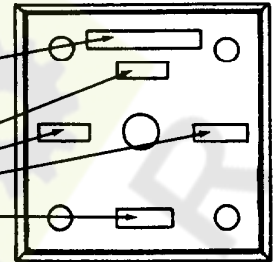

Color: Black

Code:	35
Size:	3-1/8 x 3-1/8 1/16 thick
* Title Engraving:	12 Characters
* Position Engraving	6 Characters
Letter Size:	5/32" White Letters

* Maximum recommended characters
(including spaces)

JUMPERS Ordered individually

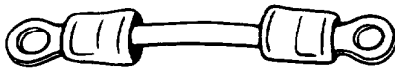

- 4.00" wire & lugs | 002012-13
- 5.38" wire & lugs | 002012-12

HANDLES

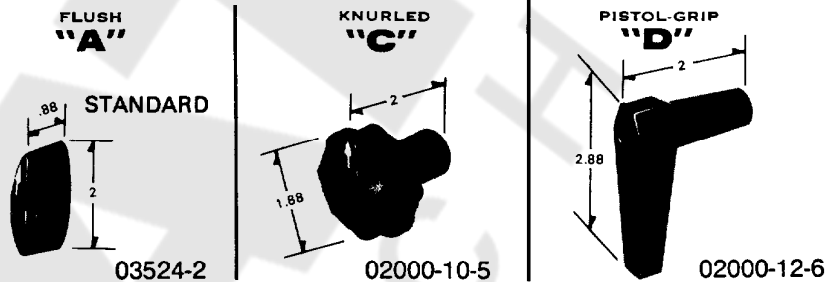

NOTE: Type "A", "C" & "D" Handles are NOT interchangeable

MOUNTING SCREW
P/N 02016-64

All dimensions in inches

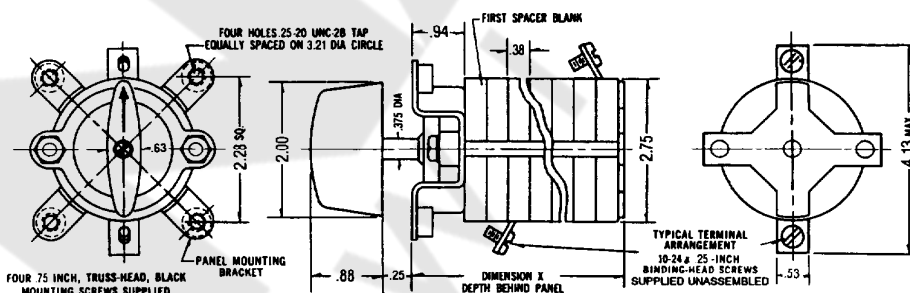

TERMINAL SCREW P/N 02016-58

PANEL DRILLING DIMENSIONS

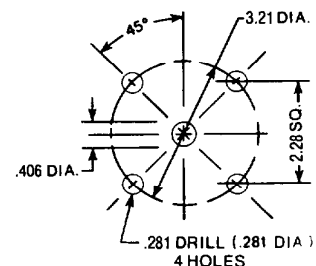

NOTE: FOR WATERPROOF MOUNTINGS:
THE (4) MOUNTING HOLES S/B .285" DIA.
THE CENTER HOLE S/B .64" DIA.
DO NOT CHAMFER MOUNTING HOLES
1/64 MAX. BREAK PERMISSIBLE



UNIT OF ELECTRO SWITCH CORP. • Weymouth, Massachusetts 02188 • Telephone: (781) 335-5200 • FAX: (781) 335-4253

SERIES 105

- 2-4 POSITIONS
- 75A/600VAC CONTINUOUS

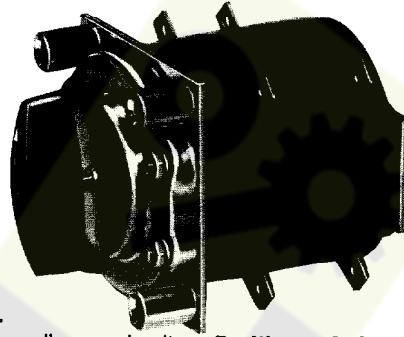

MECHANICAL

Poles: 1 to 8 depending on circuits **Positions:** 2, 3 or 4
Contacts: break-before-make (non-shorting); make-before-break (shorting)
Action: positive snap action. 90° indexing
Movement: unlimited continuous rotation in both directions or factory limited to two or three positions
Mounting: panel-mount, four through-hole mounting pads
Panel thickness: 3/16 standard
Rotor contacts: phosphor-bronze, double-grip
Stationary contacts: copper, integral with through-hole type terminals
Construction: contacts enclosed in molded-phenolic disks

ELECTRICAL

Interrupting Ratings:

60A/600VAC (60 to 400 cps 0.8 pf)
 60A/250VDC resistive load

Overload: 50 operations @ 360A/600VAC resistive

Dielectric breakdown: 2200V rms minimum

Insulation resistance: 100 megohms minimum

Contact resistance: 6 milliohms max. (1.5 milliohms average before life)

No. Poles	Catalog Number	Catalog Number	Catalog Number	Catalog Number	Catalog Number	Catalog Number	Catalog Number	Weight lbs.	Torque lb-in	Depth behind Panel	
										Cir. 1	6-7
1	105101A	105101A-2	105101A-2A	105601A	105601A-2	105601A-2A	105701A-3	4.5	32	2.62"	3.28"
2	105102A	105102A-2	105102A-2A	105602A	105602A-2	105602A-2A	105702A-3	5.0	32	3.28	3.94
3	105103A	105103A-2	105103A-2A	105603A	105603A-2	105603A-2A	105703A-3	5.5	32	3.94	4.59
4	105104A	105104A-2	105104A-2A	101604A	105604A-2	105604A-2A	105704A-3	6.0	32	4.59	5.25
5	105105A	105105A-2	105105A-2A	105605A	105605A-2	105605A-2A	105705A-3	7.0	32	5.25	5.91
6	105106A	105106A-2	105106A-2A	105606A	105606A-2	105606A-2A	105706A-3	7.5	32	5.91	6.56
7	105107A	105107A-2	105107A-2A	105607A	105607A-2	105607A-2A	105707A-3	8.0	42	6.56	7.22
8	105108A	105108A-2	105108A-2A	105608A	105608A-2	105608A-2A	105708A-3	8.5	42	7.22	7.87

Handle and terminal positions are viewed from front of panel (handle-end of switch).
 Terminal locations shown are for single-pole switches.

Torques, weights and depth behind panel in these tables are nominal.

No. Poles	Catalog Number	No. Poles	Catalog Number	No. Poles	Catalog Number	No. Poles	Catalog Number	No. Poles	Catalog Number	Weight lbs.	Torque lb-in.	Depth behind Panel	
												Cir. 2-3-4	
1	105201A	1	105201A-3	1	105301A	1	105301A-3	1	105401A	5.0	26	3.28"	
2	105202A	2	105202A-3	2	105302A	2	105302A-3	2	105402A	6.0	26	4.59	
3	105203A	3	105203A-3	3	105303A	3	105303A-3	3	105403A	7.0	26	5.91	
4	105204A	4	105204A-3	4	105304A	4	105304A-3	4	105404A	8.0	26	7.22	
5	105205A	5	105205A-3	5	105305A	5	105305A-3	5	105405A	9.0	32	8.53	
6	105206A	6	105206A-3	6	105306A	6	105306A-3	6	105406A	10.0	32	9.84	

*External jumpers not supplied

†Location of rotor blade for switch with 3 ON positions



Weymouth, Massachusetts 02188 • Telephone: (781) 335-5200 • FAX: (781) 335-4253

SERIES 105

Features...



UL File No. E80080
CIRCUIT 6 ONLY

The flush handle with arrow is standard.

For make-before-break (shorting) contacts:
add "S" (e.g. 105102A-S).

Nameplates are optional and only supplied if
requested at additional cost.

Available Options Include:
Waterproof Mountings

NAMEPLATES

Plates are secured to the panel by
the switch-mounting hardware.

LOCATION OF
TITLE ENGRAVING

TYPICAL LOCATION OF
POSITION ENGRAVING

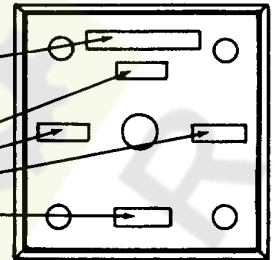

Color: Black

Code:	38
Size:	5 x 5 1/16 thick
* Title Engraving:	12 Characters
* Position Engraving	6 Characters
Letter Size:	5/32" White Letters

* Maximum recommended characters
(including spaces)

HANDLES

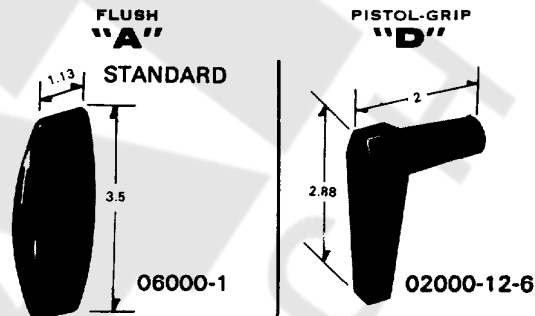

NOTE: The handles are NOT interchangeable

All dimensions in inches

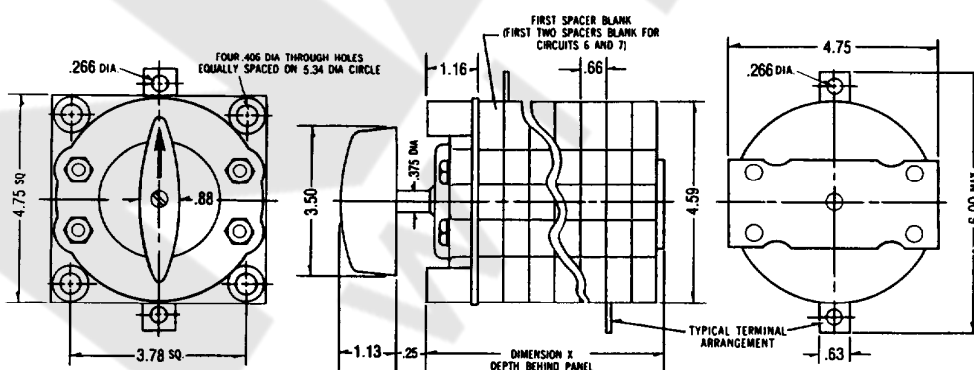

PANEL DRILLING DIMENSIONS

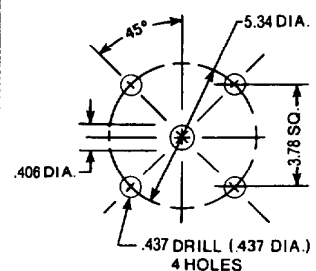

NOTE: FOR WATERPROOF MOUNTINGS:
THE (4) MOUNTING HOLES S/B .397 DIA.
THE CENTER HOLE S/B .640 DIA.
DO NOT CHAMFER MOUNTING HOLES
1/64 MAX. BREAK PERMISSIBLE



UNIT OF ELECTRO SWITCH CORP. • Weymouth, Massachusetts 02188 • Telephone: (781) 335-5200 • FAX: (781) 335-4253

SERIES 107

- 2-4 POSITIONS
- 200A/600VAC CONTINUOUS

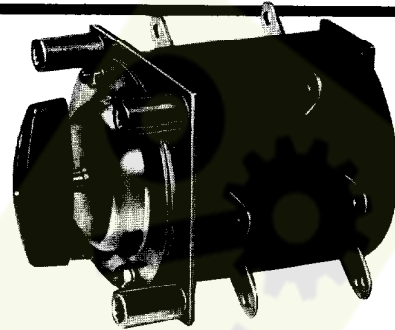

MECHANICAL

Poles: 1 to 8 depending on circuits **Positions:** 2, 3 or 4

Contacts: break-before-make (non-shorting); make-before-break (shorting)

Action: positive snap action. 90° indexing

Movement: unlimited continuous rotation in both directions or factory limited to two or three positions

Mounting: panel-mount, four through-hole mounting pads

Panel thickness: 1/4 standard

Rotor contacts: silver-plated copper or copper alloy, double-grip

Stationary contacts: silver-plated copper, integral with through-hole type terminals

Construction: contacts enclosed in molded-phenolic disks

ELECTRICAL

Interrupting Ratings:

200A/600VAC (60 to 400 cps 0.8 pf)

200A/24VDC resistive load

Overload: 50 operations @ 600A/600VAC resistive

Dielectric breakdown: 2200V rms minimum

Insulation resistance: 100 megohms minimum

Contact resistance: 1.5 milliohms max. (.5 milliohms average before life)

No. Poles	Catalog Number	CIRCUIT 1		CIRCUIT 6			CIRCUIT 7		Weight lbs.	Torque lb-in		Depth behind Panel	
		Catalog Number	Catalog Number	Catalog Number	Catalog Number	Catalog Number	Catalog Number	Cir 1		6-7	Cir. 1	6-7	
1	107101A	107101A-2	107101A-2A	107601A	107601A-2	107601A-2A	107701A-3	8	11	72	72	3.94"	4.81"
2	107102A	107102A-2	107102A-2A	107602A	107602A-2	107602A-2A	107702A-3	11	14	72	72	4.81	5.69
3	107103A	107103A-2	107103A-2A	107603A	107603A-2	107603A-2A	107703A-3	14	17	72	72	5.69	6.56
4	107104A	107104A-2	107104A-2A	107604A	107604A-2	107604A-2A	107704A-3	17	20	72	72	6.56	7.44
5	107105A	107105A-2	107105A-2A	107605A	107605A-2	107605A-2A	107705A-3	20	23	80	80	7.44	8.31
6	107106A	107106A-2	107106A-2A	107606A	107606A-2	107606A-2A	107706A-3	23	26	80	80	8.31	9.19
7	107107A	107107A-2	107107A-2A	-	-	-	-	26		80		9.19	
8	107108A	107108A-2	107108A-2A	-	-	-	-	27		80		10.06	

Handle and terminal positions are viewed from front of panel (handle-end of switch).

Terminal locations shown are for single-pole switches.

Torques, weights and depth behind panel in these tables are nominal.

No. Poles	Catalog Number	CIRCUIT 2		CIRCUIT 3		CIRCUIT 4		Weight lbs.	Torque lb-in.	Depth behind Panel
		No. Poles	Catalog Number	No. Poles	Catalog Number	No. Poles	Catalog Number			
1	107201A	1	107201A-3	1	107301A	1	107401A	12	72	4.81"
2	107202A	2	107202A-3	2	107302A	2	107402A	18	72	6.56
3	107203A	3	107203A-3	3	107303A	3	107403A	24	72	8.31
4	107204A	4	107204A-3	4	107304A	4	107404A	30	72	10.06
5	107205A	5	107205A-3	5	107305A	5	107405A	36	80	11.81
6	107206A	6	107206A-3	6	107306A	6	107406A	42	80	13.56

*External jumpers not supplied

†Location of rotor blade for switch with 3 ON positions



UNIT OF ELECTRO SWITCH CORP. • Weymouth, Massachusetts 02188 • Telephone: (781) 335-5200 • FAX: (781) 335-4253

**SERIES 107
Features...**



UL File No. E80080
CIRCUIT 6 ONLY

The flush handle with arrow is standard.

For make-before-break (shorting) contacts:
add "S" (e.g. 107102A-S).

Nameplates are optional and only supplied if
requested at additional cost.

Available Option:
Waterproof Mounting

NAMEPLATES

Plates are secured to the panel by
the switch-mounting hardware.

LOCATION OF
TITLE ENGRAVING

TYPICAL LOCATION OF
POSITION ENGRAVING

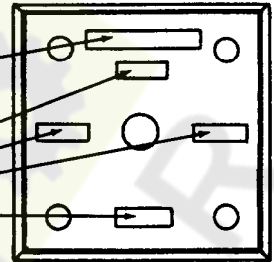

Color: Black

Code:	41
Size:	6-3/4 x 6-3/4 1/16 thick
* Title Engraving:	12 Characters
* Position Engraving	6 Characters
Letter Size:	1/4" White Letters

* Maximum recommended characters
(including spaces)

HANDLES

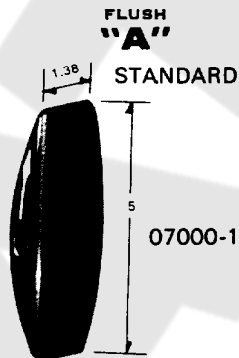

DOUBLE BALL HANDLE

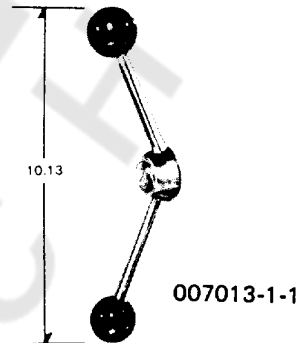

NOTE: The handles are NOT interchangeable

All dimensions in inches

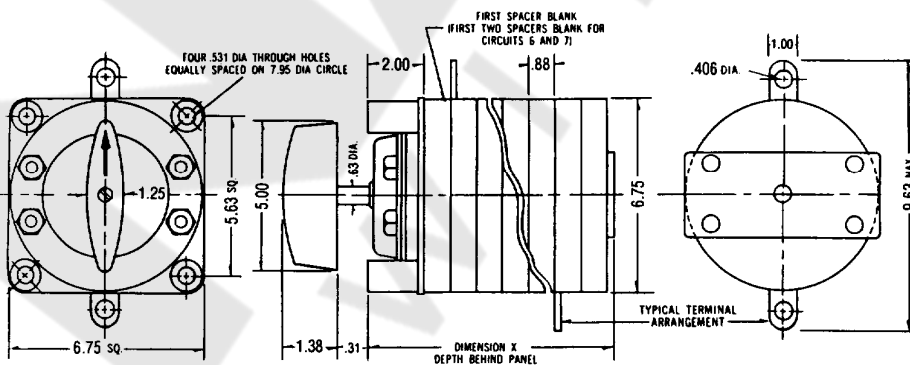

PANEL DRILLING DIMENSIONS

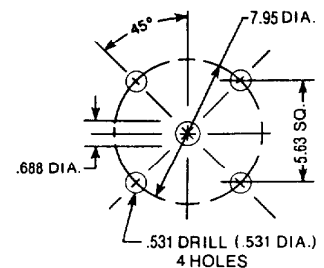

NOTE: FOR WATERPROOF MOUNTINGS
THE (4) MOUNTING HOLES S/B .515" DIA.
THE CENTER HOLE S/B .785" DIA.
DO NOT CHAMFER MOUNTING HOLES
1/64 MAX. BREAK PERMISSIBLE



UNIT OF ELECTRO SWITCH CORP. • Weymouth, Massachusetts 02188 • Telephone: (781) 335-5200 • FAX: (781) 335-4253

TYPICAL SNAP-ACTION SWITCH CIRCUITS

(Nameplates and jumpers not supplied)

APPLICATION	POSITIONS	"X" CHART & WIRING	HOW WE MAKE THEM																																										
REVERSING SWITCH THREE PHASE Standard oval handle Series Cat. No. 101 101703A-3 103 103703A-3 105 105703A-3 107 107703A-3		<table border="1"> <thead> <tr> <th>POS.</th> <th>CONTACTS</th> <th>POS.</th> <th>REL.</th> <th>OFF</th> <th>FOR</th> </tr> </thead> <tbody> <tr> <td>1</td> <td>10-11-02</td> <td>X</td> <td>X</td> <td>X</td> <td>X</td> </tr> <tr> <td>2</td> <td>11-01-03</td> <td>X</td> <td>X</td> <td>X</td> <td>X</td> </tr> <tr> <td>3</td> <td>11-01-04</td> <td>X</td> <td>X</td> <td>X</td> <td>X</td> </tr> <tr> <td>4</td> <td>11-01-05</td> <td>X</td> <td>X</td> <td>X</td> <td>X</td> </tr> <tr> <td>5</td> <td>11-01-08</td> <td>X</td> <td>X</td> <td>X</td> <td>X</td> </tr> </tbody> </table> <p>Jumpers NOT supplied</p>	POS.	CONTACTS	POS.	REL.	OFF	FOR	1	10-11-02	X	X	X	X	2	11-01-03	X	X	X	X	3	11-01-04	X	X	X	X	4	11-01-05	X	X	X	X	5	11-01-08	X	X	X	X	<p>Break-before-make contacts</p>						
POS.	CONTACTS	POS.	REL.	OFF	FOR																																								
1	10-11-02	X	X	X	X																																								
2	11-01-03	X	X	X	X																																								
3	11-01-04	X	X	X	X																																								
4	11-01-05	X	X	X	X																																								
5	11-01-08	X	X	X	X																																								
WYE DELTA CHANGEOVER SWITCH for motor speed control Standard oval handle Series Cat. No. 101 101603A-2 103 103603A-2 105 105603A-2 107 107603A-2		<table border="1"> <thead> <tr> <th>POS.</th> <th>CONTACTS</th> <th>POS.</th> <th>REL.</th> <th>OFF</th> <th>DELTA</th> </tr> </thead> <tbody> <tr> <td>1</td> <td>10-11-02</td> <td>X</td> <td>X</td> <td>X</td> <td>X</td> </tr> <tr> <td>2</td> <td>11-01-03</td> <td>X</td> <td>X</td> <td>X</td> <td>X</td> </tr> <tr> <td>3</td> <td>11-01-04</td> <td>X</td> <td>X</td> <td>X</td> <td>X</td> </tr> <tr> <td>4</td> <td>11-01-05</td> <td>X</td> <td>X</td> <td>X</td> <td>X</td> </tr> <tr> <td>5</td> <td>11-01-08</td> <td>X</td> <td>X</td> <td>X</td> <td>X</td> </tr> <tr> <td>6</td> <td>11-01-09</td> <td>X</td> <td>X</td> <td>X</td> <td>X</td> </tr> </tbody> </table> <p>Jumpers NOT supplied</p>	POS.	CONTACTS	POS.	REL.	OFF	DELTA	1	10-11-02	X	X	X	X	2	11-01-03	X	X	X	X	3	11-01-04	X	X	X	X	4	11-01-05	X	X	X	X	5	11-01-08	X	X	X	X	6	11-01-09	X	X	X	X	<p>Break-before-make contacts</p>
POS.	CONTACTS	POS.	REL.	OFF	DELTA																																								
1	10-11-02	X	X	X	X																																								
2	11-01-03	X	X	X	X																																								
3	11-01-04	X	X	X	X																																								
4	11-01-05	X	X	X	X																																								
5	11-01-08	X	X	X	X																																								
6	11-01-09	X	X	X	X																																								
SHIP-TO-SHORE CHANGEOVER SWITCH Standard oval handle Series Cat. No. 101 101602A-2A 103 103602A-2A 105 105602A-2A 107 107602A-2A		<table border="1"> <thead> <tr> <th>POS.</th> <th>CONTACTS</th> <th>POS.</th> <th>REL.</th> <th>OFF</th> <th>SHORE</th> </tr> </thead> <tbody> <tr> <td>1</td> <td>10-11-02</td> <td>X</td> <td>X</td> <td>X</td> <td>X</td> </tr> <tr> <td>2</td> <td>11-01-03</td> <td>X</td> <td>X</td> <td>X</td> <td>X</td> </tr> <tr> <td>3</td> <td>11-01-04</td> <td>X</td> <td>X</td> <td>X</td> <td>X</td> </tr> <tr> <td>4</td> <td>11-01-05</td> <td>X</td> <td>X</td> <td>X</td> <td>X</td> </tr> </tbody> </table> <p>Jumpers NOT supplied</p>	POS.	CONTACTS	POS.	REL.	OFF	SHORE	1	10-11-02	X	X	X	X	2	11-01-03	X	X	X	X	3	11-01-04	X	X	X	X	4	11-01-05	X	X	X	X	<p>Break-before-make contacts</p>												
POS.	CONTACTS	POS.	REL.	OFF	SHORE																																								
1	10-11-02	X	X	X	X																																								
2	11-01-03	X	X	X	X																																								
3	11-01-04	X	X	X	X																																								
4	11-01-05	X	X	X	X																																								

TYPICAL INSTRUMENT SWITCHES

(Supplied with nameplates and assembled jumpers as shown)

APPLICATION	POSITIONS	"X" CHART & WIRING	HOW WE MAKE THEM																																																																																																																																
VOLTMETER TRANSFER SWITCH 3 phase - phase-to-phase Standard knurled handle Series 101 cat.# 10104C Series 103 cat.# 10304C		<table border="1"> <thead> <tr> <th>POS.</th> <th>CONTACTS</th> <th>POS.</th> <th>REL.</th> <th>OFF</th> <th>1-2</th> <th>2-3</th> </tr> </thead> <tbody> <tr> <td>1</td> <td>11-02</td> <td>X</td> <td>X</td> <td>X</td> <td>X</td> <td>X</td> </tr> <tr> <td>2</td> <td>10-11-03</td> <td>X</td> <td>X</td> <td>X</td> <td>X</td> <td>X</td> </tr> <tr> <td>3</td> <td>11-04</td> <td>X</td> <td>X</td> <td>X</td> <td>X</td> <td>X</td> </tr> <tr> <td>4</td> <td>11-06</td> <td>X</td> <td>X</td> <td>X</td> <td>X</td> <td>X</td> </tr> <tr> <td>5</td> <td>11-07</td> <td>X</td> <td>X</td> <td>X</td> <td>X</td> <td>X</td> </tr> <tr> <td>6</td> <td>11-08</td> <td>X</td> <td>X</td> <td>X</td> <td>X</td> <td>X</td> </tr> </tbody> </table> <p>Nameplates and jumpers supplied</p>	POS.	CONTACTS	POS.	REL.	OFF	1-2	2-3	1	11-02	X	X	X	X	X	2	10-11-03	X	X	X	X	X	3	11-04	X	X	X	X	X	4	11-06	X	X	X	X	X	5	11-07	X	X	X	X	X	6	11-08	X	X	X	X	X	<p>Break-before-make contacts</p>																																																																															
POS.	CONTACTS	POS.	REL.	OFF	1-2	2-3																																																																																																																													
1	11-02	X	X	X	X	X																																																																																																																													
2	10-11-03	X	X	X	X	X																																																																																																																													
3	11-04	X	X	X	X	X																																																																																																																													
4	11-06	X	X	X	X	X																																																																																																																													
5	11-07	X	X	X	X	X																																																																																																																													
6	11-08	X	X	X	X	X																																																																																																																													
AMMETER TRANSFER SWITCH 3 Phase 3 Current Transformers Standard knurled handle Series 101 cat.# 10110C Series 103 cat.# 10310C		<table border="1"> <thead> <tr> <th>POS.</th> <th>CONTACTS</th> <th>POSITIONS</th> <th>REL.</th> <th>OFF</th> <th>1</th> <th>2</th> <th>3</th> </tr> </thead> <tbody> <tr> <td>1</td> <td>11-02</td> <td>X</td> <td>X</td> <td>X</td> <td>X</td> <td>X</td> <td>X</td> </tr> <tr> <td>2</td> <td>10-11-03</td> <td>X</td> <td>X</td> <td>X</td> <td>X</td> <td>X</td> <td>X</td> </tr> <tr> <td>3</td> <td>11-04</td> <td>X</td> <td>X</td> <td>X</td> <td>X</td> <td>X</td> <td>X</td> </tr> <tr> <td>4</td> <td>11-06</td> <td>X</td> <td>X</td> <td>X</td> <td>X</td> <td>X</td> <td>X</td> </tr> <tr> <td>5</td> <td>11-07</td> <td>X</td> <td>X</td> <td>X</td> <td>X</td> <td>X</td> <td>X</td> </tr> <tr> <td>6</td> <td>11-08</td> <td>X</td> <td>X</td> <td>X</td> <td>X</td> <td>X</td> <td>X</td> </tr> <tr> <td>7</td> <td>11-09</td> <td>X</td> <td>X</td> <td>X</td> <td>X</td> <td>X</td> <td>X</td> </tr> </tbody> </table> <p>*denotes make-before-break Nameplates and jumpers supplied</p>	POS.	CONTACTS	POSITIONS	REL.	OFF	1	2	3	1	11-02	X	X	X	X	X	X	2	10-11-03	X	X	X	X	X	X	3	11-04	X	X	X	X	X	X	4	11-06	X	X	X	X	X	X	5	11-07	X	X	X	X	X	X	6	11-08	X	X	X	X	X	X	7	11-09	X	X	X	X	X	X	<p>Make-before-break (shorting) contacts</p>																																																																
POS.	CONTACTS	POSITIONS	REL.	OFF	1	2	3																																																																																																																												
1	11-02	X	X	X	X	X	X																																																																																																																												
2	10-11-03	X	X	X	X	X	X																																																																																																																												
3	11-04	X	X	X	X	X	X																																																																																																																												
4	11-06	X	X	X	X	X	X																																																																																																																												
5	11-07	X	X	X	X	X	X																																																																																																																												
6	11-08	X	X	X	X	X	X																																																																																																																												
7	11-09	X	X	X	X	X	X																																																																																																																												
AMMETER-VOLTMETER TRANSFER SWITCH 3 Phase Phase-to-phase 3 Current Transformers Standard knurled handle Series 101 cat.# 10115C Series 103 cat.# 10315C		<table border="1"> <thead> <tr> <th>POS.</th> <th>CONTACTS</th> <th>POSITIONS</th> <th>REL.</th> <th>OFF</th> <th>1</th> <th>2</th> <th>3</th> </tr> </thead> <tbody> <tr> <td>1</td> <td>11-02</td> <td>X</td> <td>X</td> <td>X</td> <td>X</td> <td>X</td> <td>X</td> </tr> <tr> <td>2</td> <td>10-11-03</td> <td>X</td> <td>X</td> <td>X</td> <td>X</td> <td>X</td> <td>X</td> </tr> <tr> <td>3</td> <td>11-04</td> <td>X</td> <td>X</td> <td>X</td> <td>X</td> <td>X</td> <td>X</td> </tr> <tr> <td>4</td> <td>11-06</td> <td>X</td> <td>X</td> <td>X</td> <td>X</td> <td>X</td> <td>X</td> </tr> <tr> <td>5</td> <td>11-07</td> <td>X</td> <td>X</td> <td>X</td> <td>X</td> <td>X</td> <td>X</td> </tr> <tr> <td>6</td> <td>11-08</td> <td>X</td> <td>X</td> <td>X</td> <td>X</td> <td>X</td> <td>X</td> </tr> <tr> <td>7</td> <td>11-09</td> <td>X</td> <td>X</td> <td>X</td> <td>X</td> <td>X</td> <td>X</td> </tr> <tr> <td>8</td> <td>11-10</td> <td>X</td> <td>X</td> <td>X</td> <td>X</td> <td>X</td> <td>X</td> </tr> <tr> <td>9</td> <td>11-11</td> <td>X</td> <td>X</td> <td>X</td> <td>X</td> <td>X</td> <td>X</td> </tr> <tr> <td>10</td> <td>11-12</td> <td>X</td> <td>X</td> <td>X</td> <td>X</td> <td>X</td> <td>X</td> </tr> <tr> <td>11</td> <td>11-13</td> <td>X</td> <td>X</td> <td>X</td> <td>X</td> <td>X</td> <td>X</td> </tr> <tr> <td>12</td> <td>11-14</td> <td>X</td> <td>X</td> <td>X</td> <td>X</td> <td>X</td> <td>X</td> </tr> <tr> <td>13</td> <td>11-15</td> <td>X</td> <td>X</td> <td>X</td> <td>X</td> <td>X</td> <td>X</td> </tr> <tr> <td>14</td> <td>11-16</td> <td>X</td> <td>X</td> <td>X</td> <td>X</td> <td>X</td> <td>X</td> </tr> <tr> <td>15</td> <td>11-17</td> <td>X</td> <td>X</td> <td>X</td> <td>X</td> <td>X</td> <td>X</td> </tr> </tbody> </table> <p>*denotes make-before-break Nameplates and jumpers supplied</p>	POS.	CONTACTS	POSITIONS	REL.	OFF	1	2	3	1	11-02	X	X	X	X	X	X	2	10-11-03	X	X	X	X	X	X	3	11-04	X	X	X	X	X	X	4	11-06	X	X	X	X	X	X	5	11-07	X	X	X	X	X	X	6	11-08	X	X	X	X	X	X	7	11-09	X	X	X	X	X	X	8	11-10	X	X	X	X	X	X	9	11-11	X	X	X	X	X	X	10	11-12	X	X	X	X	X	X	11	11-13	X	X	X	X	X	X	12	11-14	X	X	X	X	X	X	13	11-15	X	X	X	X	X	X	14	11-16	X	X	X	X	X	X	15	11-17	X	X	X	X	X	X	<p>Break-before-make contacts</p>
POS.	CONTACTS	POSITIONS	REL.	OFF	1	2	3																																																																																																																												
1	11-02	X	X	X	X	X	X																																																																																																																												
2	10-11-03	X	X	X	X	X	X																																																																																																																												
3	11-04	X	X	X	X	X	X																																																																																																																												
4	11-06	X	X	X	X	X	X																																																																																																																												
5	11-07	X	X	X	X	X	X																																																																																																																												
6	11-08	X	X	X	X	X	X																																																																																																																												
7	11-09	X	X	X	X	X	X																																																																																																																												
8	11-10	X	X	X	X	X	X																																																																																																																												
9	11-11	X	X	X	X	X	X																																																																																																																												
10	11-12	X	X	X	X	X	X																																																																																																																												
11	11-13	X	X	X	X	X	X																																																																																																																												
12	11-14	X	X	X	X	X	X																																																																																																																												
13	11-15	X	X	X	X	X	X																																																																																																																												
14	11-16	X	X	X	X	X	X																																																																																																																												
15	11-17	X	X	X	X	X	X																																																																																																																												



ELECTROSWITCH

UNIT OF ELECTRO SWITCH CORP. • Weymouth, Massachusetts 02188 • Telephone: (781) 335-5200 • FAX: (781) 335-4253

About Electroswitch ...

Electroswitch is an acknowledged leader in the electrical industry. Nearly 50 years of experience goes into the design and manufacturing of our quality rotary power switches. The application of these switches for control of complex power systems through centralized switchboards and panels has been our speciality in the industrial, electrical utility and military fields.

In addition to being the first choice of electrical utilities, Electroswitch rotary power switches and relays are specified by manufacturers of high quality heavy-duty control systems. These range from hi-shock Naval ship-board and nuclear reactor control to rugged industrial equipment such as locomotives, tractors and other high vibration and hi-shock applications. Their durability and reliability have proved to be the most economical solutions for our customers' most taxing applications. The dependability of our switches is the result of sound design, careful manufacturing and rigid quality control. When a product line is as specialized and as critical in application as ours, we have to do the job right the first time ... and every time ... to support our customers' demands for the highest quality and reliability.

The ability to custom design rotary power switches to precisely fit every application has taken Electroswitch into many unique applications. The opportunity to choose among the distinct families of rotary power switches (Detent and Snap-action) assures our customers that the correct switch is used for their most critical needs.

Economy is inherent in the design of all our rotary power switches. The modular constructions permit literally millions of different rugged and reliable switches to be built from an inventory of a few basic parts. Our use of the latest manufacturing techniques and methods also assures a reliable product ... at lower cost. Equally as important to our customers, Electroswitch traditionally exceeds standards for on-time, prompt deliveries.

Our test laboratory includes the equipment necessary for most endurance and environmental testing and quality assurance. Testing is performed to meet the requirements of UL 1054, UL 508, CSA 22/2, ANSI/IEEE 323-1984, MIL-S-6807, MIL-S-21604, MIL-S-15291 and many other customer, industry and military specifications.

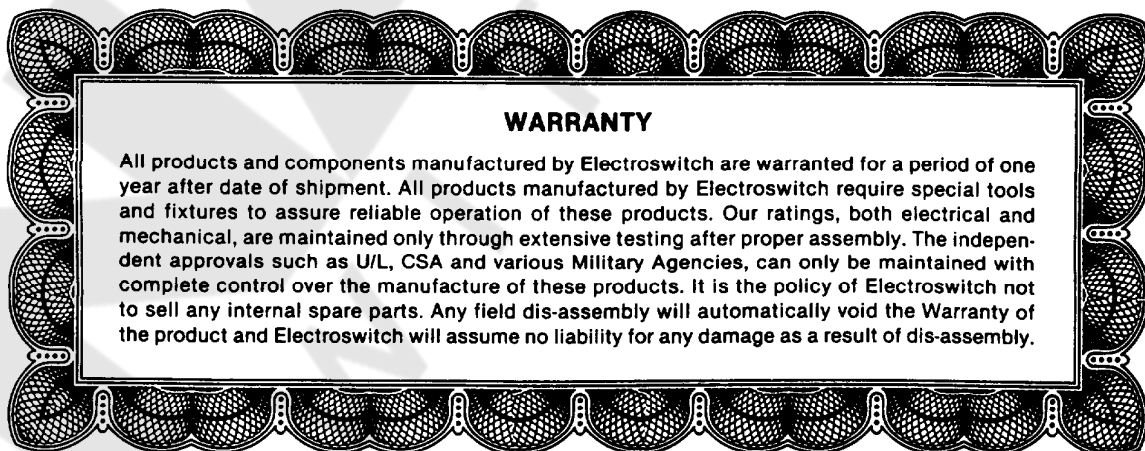

Printed in U.S.A.
© 1996 Electroswitch
SP 698/10M

ELECTROSWITCH ROTARY SWITCHES INCLUDE THE FOLLOWING PRODUCT LINES

- **DETENT-ACTION SWITCHES (Catalog IND-1)**
- **SNAP-ACTION SWITCHES (Catalog IND-1)**
- **CAM-ACTION SWITCHES (Catalog CAM-1)**
 - **TAP & KNIFE SWITCHES**

FOR ELECTRICAL UTILITY APPLICATIONS

- **INSTRUMENT & CONTROL SWITCHES**
 - **W/W2 CONTROL SWITCHES**
 - **LOCK-OUT RELAYS**
 - **CONTROL SWITCH RELAYS**
- **SELECTOR & LATCHING SWITCH RELAYS**
 - **TAGGING RELAYS**

FOR MILITARY APPLICATIONS

**DETENT AND SNAP-ACTION
ROTARY SWITCHES
TO MIL-S SPECIFICATIONS**



ELECTROSWITCH

UNIT OF ELECTRO SWITCH CORP. • Weymouth, Massachusetts 02188 • Telephone: (781) 335-5200 • FAX: (781) 335-4253



ELECTROSWITCH
• SWITCHES & RELAYS

UNIT OF ELECTRO SWITCH CORP.

180 King Avenue, Weymouth, Massachusetts 02188

Telephone: (781) 335-5200 • FAX: (781) 335-4253
www.electroswitch.com