

1. CURRENT TRANSFORMERS

Support type

Support window type

Generator / Wall-bushing type

Touch-proof type

Wall-bushing with primary bar type



1. CURRENT TRANSFORMERS

INTRODUCTION

Current transformers reduce the current in the Medium Voltage line to proportional and manageable values, and separate the measuring instruments, meters, relays, etc. from the power circuit.

SECTION

1. Primary terminals
2. Insulation (resin)
3. Primary winding
4. Core and secondary winding
5. Secondary terminal box
6. Base
7. Earth terminal

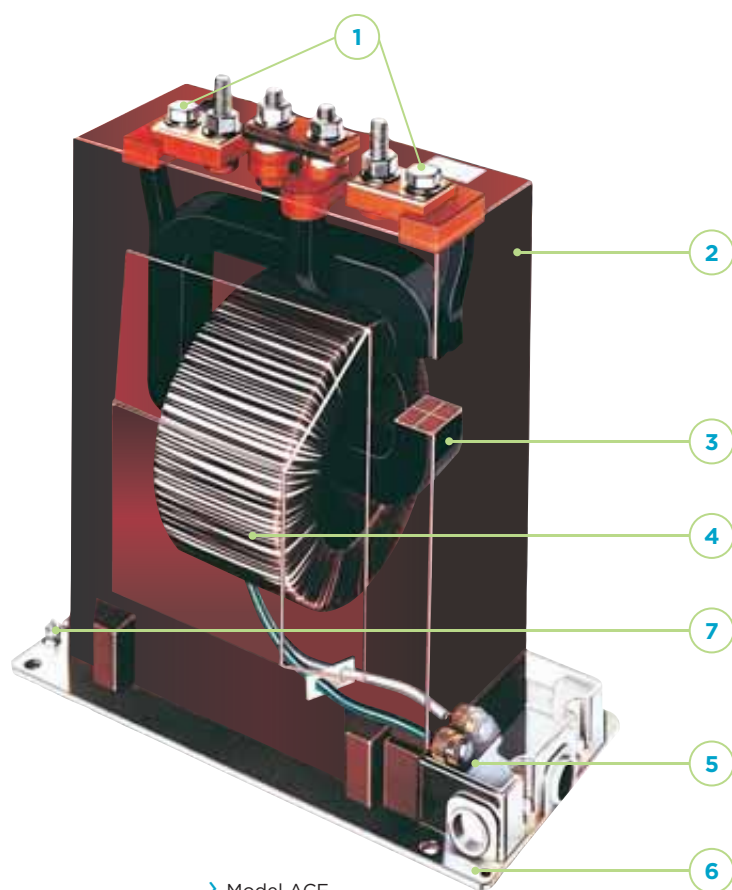

› Model ACF



Support type



Support window type



Generator / Wall-bushing type



Touch-proof type



Wall-bushing with primary bar type



› ACM-12
Support type
transformer for primary
distribution switchgears.



› ABG-24
Current transformer for generator
designed to work with very high
primary currents.

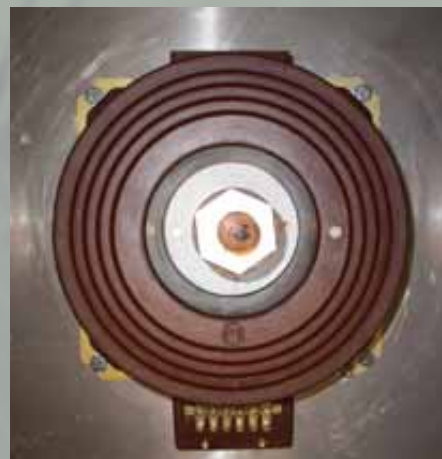

› ABD-36
Wall-bushing type
transformer with short-
circuitable secondaries.

1. CURRENT TRANSFORMERS > Support type

SUPPORT TYPE

Current transformers for indoor service, encapsulated in resin which in addition to their primary function also act as busbar supports.

RANGE

- > Insulation voltage from 3.6 kV to 72.5 kV.
- > Rated primary currents from 1 A to 3000 A.
- > Secondary currents: 1 and 5 A.
- > Frequencies: 50 Hz, 60 Hz.

APPLICATIONS

- > Medium voltage air insulated primary distribution switchgears.
- > Medium voltage air insulated secondary distribution switchgears.
- > Capacitor Banks.

ADVANTAGES

- > Possibility of secondary currents different from the standardized ones (1 and 5 A).
- > Possibility of frequencies different from the standardized ones (50 and 60 Hz).
- > Secondary terminals on the P1 or P2 side.
- > Designed to withstand vibrations.
- > Excellent response under extreme weather conditions.
- > Short-circuit system for secondary terminals and dimensions as per with DIN 42600 available.
- > Ratio change by primary or secondary tapping.
- > Stainless steel screws, bolts and nuts available.
- > It can be assembled in any position (vertical, horizontal, etc.).
- > Designs approved by Underwriters Laboratories (UL-USA) available.



> Model ACF



> Model ACD

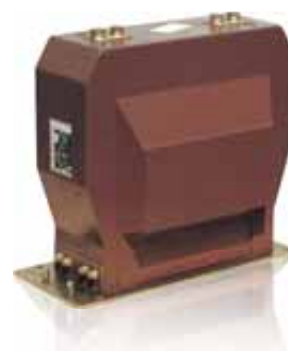

> Model ACH



> Model ACK



> Model ACJ

1. CURRENT TRANSFORMERS > Support type

MARKING

> SINGLE PRIMARY RATIO AND ONE SECONDARY



> DOUBLE PRIMARY RATIO BY SECONDARY TAPPING AND ONE SECONDARY



> SINGLE PRIMARY RATIO AND TWO SECONDARIES



> DOUBLE PRIMARY RATIO AND ONE SECONDARY

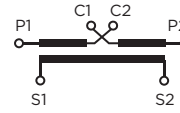

> SINGLE PRIMARY RATIO AND THREE SECONDARIES



> SINGLE PRIMARY RATIO AND TWO SECONDARIES WITH TAPS



> DOUBLE PRIMARY RATIO AND TWO SECONDARIES

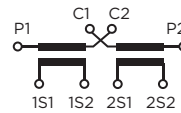

Electrical characteristics

Model	Highest voltage (kV)	Rated insulation level		Maximum primary current (A)		Short-circuit current I_{th}			Maximum number of cores
		Power frequency (kV)	Lightning impulse (BIL) (kVp)	S.R.	D.R.	Short-circuit current I_{th}		I_{din} (A)	
						S.R.	D.R.		
ACD-7	7,2	20	60	1200	2x600	96	50	$2.5 \times I_{th}$	2
ACD-12	12	28	75	1200	2x600	96	50	$2.5 \times I_{th}$	2
ACF-12	12	28	75	2000	2x600	100	50	$2.5 \times I_{th}$	3
ACI-12	12	28	75	2000	2x600	100	50	$2.5 \times I_{th}$	3
ACIL-12	12	28	75	2000	2x600	100	50	$2.5 \times I_{th}$	3
ACM-12	12	28	75	2500	2x1000	100	50	$2.5 \times I_{th}$	3
ACD-17	17,5	38	95	1200	2x600	96	50	$2.5 \times I_{th}$	2
CID-17	17,5	38	95	600	-	48	-	$2.5 \times I_{th}$	1
ACF-17	17,5	38	95	2000	2x600	100	50	$2.5 \times I_{th}$	3
ACFR-17	17,5	38	95	2000	2x600	100	50	$2.5 \times I_{th}$	3
ACH-17	17,5	38	95	2000	2x600	100	50	$2.5 \times I_{th}$	3
ACI-17	17,5	38	95	2000	2x600	100	50	$2.5 \times I_{th}$	3
ACIL-17	17,5	38	95	2000	2x600	100	50	$2.5 \times I_{th}$	3
ACD-24	24	50	125	1200	2x600	96	50	$2.5 \times I_{th}$	2
ACF-24	24	50	125	2000	2x600	100	50	$2.5 \times I_{th}$	3
ACH-24	24	50	125	2500	2x600	100	50	$2.5 \times I_{th}$	3
ACJ-24	24	50	125	2500	2x600	100	50	$2.5 \times I_{th}$	3
ACJL-24	24	50	125	2500	2x600	100	50	$2.5 \times I_{th}$	3
ACM-24	24	50	125	2500	2x1000	100	50	$2.5 \times I_{th}$	3
ACA-36	36	70	170	1200	2x600	96	50	$2.5 \times I_{th}$	1
ACF-36	36	70	170	2500	2x600	100	50	$2.5 \times I_{th}$	3
ACH-36	36	70	170	2500	2x800	100	50	$2.5 \times I_{th}$	3
ACM-36	36	70	170	2500	2x1000	100	50	$2.5 \times I_{th}$	3
ACK-52	52	95	250	2000	2x600	100	50	$2.5 \times I_{th}$	3
ACK-72	72,5	140	325	2500	2x1000	100	50	$2.5 \times I_{th}$	3
ACP-72	72,5	140	325	2500	2x1000	100	50	$2.5 \times I_{th}$	3

Triple primary ratio available. Please consult for details.
Subject to technical change.

1. CURRENT TRANSFORMERS > Support type

DIMENSIONS

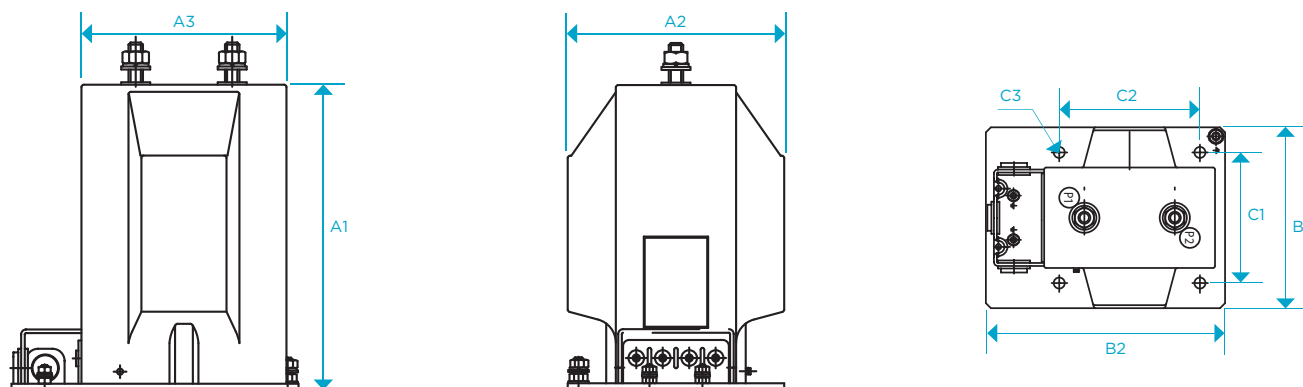

Dimensions and weights

Model	Dimensions (mm)			Base (mm)		Mounting (mm)			Weight (kg)
	Height (A1)	Width (A2)	Length (A3)	Width (B1)	Length (B2)	Width (C1)	Length (C2)	Hole diameter (C3)	
ACD-7	255	180	170	180	238	130	140	11	16
ACD-12	255	180	170	180	238	130	140	11	16
ACF-12	245	178	270	178	353	150/155	280/295	11	27
ACI-12	220	148	270	148	337.5	125	270	11	23
ACIL-12	220	148	395	148	472	120	420	12	34
ACM-12	395	260	446	178	408	175	350	11	80
ACD-17	255	180	170	180	238	130	140	11	16
CID-17	140	120	178	120.6	212	95.2	141/151	10	15
ACF-17	245	178	270	178	295	150/155	280/295	11	27
ACFR-17	240	168	270	168	353	145	225	11	26.5
ACH-17	220	178	307	178	380	150	283.5/310.5	11	25
ACI-17	220	148	270	148	337.5	125	270	11	23
ACIL-17	220	148	395	148	472	125	420	12	34
ACD-24	255	180	170	180	238	130	140	11	16
ACF-24	245	178	270	178	295	150/155	280/295	11	27
ACH-24	245	178	325	175	405	155	350	11	33
ACJ-24	280	178	270	178	345	150	280	14	35
ACJL-24	280	178	395	178	472	150	420	12	34
ACM-24	395	260	446	178	408	175	350	11	80
ACA-36	340	170	170	178	178	130	140	11	16
ACF-36	355	210	270	178	353	150/155	280/295	11	36
ACH-36	354	210	375	178	405	155	350	11	51
ACM-36	395	260	446	178	408	175	350	11	80
ACK-52	475	280	330	230	407	200	250/260	14	70
ACK-72	650	310	355	310	417.5	225	300	14	105
ACP-72	872	355	355	340	429.5	255	300	14	110

Brass primary terminals (silver-plated on request) with M12 zinc-plated, bichromated steel screw.
 Brass M5/M6 secondary terminals. Zinc-plated, bichromated steel M8/M12 earth terminals.
 Polycarbonate secondary terminal cover. Zinc-plated, bichromated steel covers available on request.
 Approximate dimensions and weights.

SUPPORT WINDOW TYPE

Current transformers for indoor service, encapsulated in resin. Toroidal support type without primary conductor to be installed in medium voltage busbars without insulation.

RANGE

- > Insulation voltage from 3.6 kV to 24 kV.
- > Rated primary currents up to 4000 A.
- > Secondary currents: 1 and 5 A
- > Frequencies: 50 Hz, 60 Hz.

APPLICATIONS

- > Medium voltage air insulated primary distribution switchgears.
- > Capacitor Banks.

ADVANTAGES

- > Possibility of secondary currents different from the standardized ones (1 and 5 A).
- > Rated primary currents over 4000 A available.
- > Secondary terminals on the P1 or P2 side.
- > Designs for outdoor service available.
- > Stainless steel screws, bolts and nuts available.



> Model AGNE



> Model AGN



> Model AGPE



> Model AGD



> Model AGNL



> AGN-24
Transformer for
generator switchgear.

1. CURRENT TRANSFORMERS > Support window type

MARKING

> SINGLE PRIMARY RATIO AND ONE SECONDARY



> DOUBLE PRIMARY RATIO BY SECONDARY TAPPING AND ONE SECONDARY



> SINGLE PRIMARY RATIO AND TWO SECONDARIES



> SINGLE PRIMARY RATIO AND THREE SECONDARIES

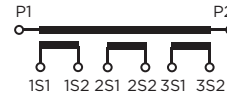

> SINGLE PRIMARY RATIO AND TWO SECONDARIES WITH TAPS



Electrical characteristics

Model	Highest voltage (kV)	Rated insulation level		Maximum primary current (A)	Short-circuit current I_{th}		Maximum number of cores
		Power frequency (kV)	Lightning impulse (BIL) (kVp)		I_{th} (kA/1s)	I_{din} (kA)	
AGNE-3.6	3.6	10	40	4000	100	$2.5 \times I_{th}$	3
AGPE-3.6	3.6	10	40	4000	100	-	3
AGPE-12	12	28	75	4000	100	$2.5 \times I_{th}$	3
AGN-17	17.5	38	95	4000	100	$2.5 \times I_{th}$	3
AGNL-17	17.5	38	95	4000	100	$2.5 \times I_{th}$	4
AGD-24	24	50	125	1500	100	$2.5 \times I_{th}$	1
AGN-24	24	50	125	4000	100	$2.5 \times I_{th}$	3

Subject to technical change.

DIMENSIONS

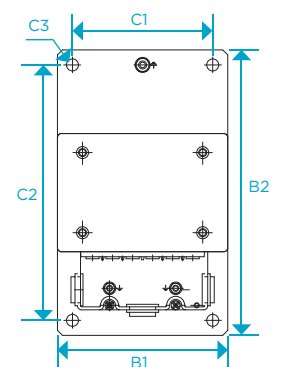
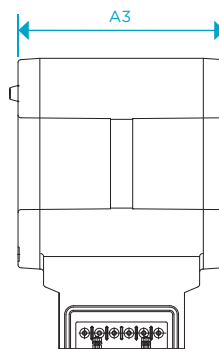
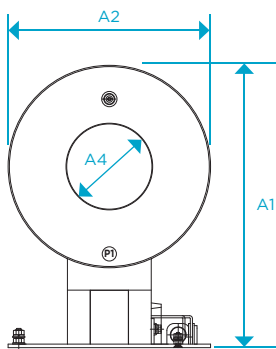

Dimensions and weights

Model	Dimensions (mm)				Base (mm)		Mounting (mm)			Weight (kg)
	Height (A1)	Width (A2)	Length (A3)	Inner diameter (A4)	Width (B1)	Length (B2)	Width (C1)	Length (C2)	Hole diameter (C3)	
AGNE-3.6	397.5	285	230/280	120/150	307	170	255	140	12	42
AGPE-3.6	498	370	160	200	370	160	270	130	11	33
AGPE-12	516	370	290	204	290	370	130	270	11	55
AGN-17	397.5	285	230/280	120/150	285	170	255	140	12	42
AGNL-17	400	290	330	120/140	285	330	255	140	12	55
AGD-24	360	160	156	-	-	-	63	-	M8	11
AGN-24	397.5	285	230/280	120/150	285	170	255	140	12	42

Option to supply with silver-plated copper primary bar on request.
 Brass M5/M6 secondary terminals. Zinc-plated, bichromated steel M8/M12 earth terminals.
 Polycarbonate secondary terminal cover. Zinc-plated, bichromated steel covers available on request.
 Approximate dimensions and weights.

GENERATOR TYPE

Current transformers for indoor service, encapsulated in resin. Toroidal type without primary conductor to be installed in generator outputs.

RANGE

- › Insulation voltage up to 24 kV.
- › Rated primary currents up to 12,000 A.
- › Higher currents available.
- › Secondary currents: 1 and 5 A.
- › Frequencies: 50 Hz, 60 Hz.

APPLICATIONS

- › Power generation.

ADVANTAGES

- › Measurement and protection applications.
- › Excellent performance in ambient temperatures up to 80°C.
- › Stainless steel screws, bolts and nuts available.



› Model ABG



› Model ABF

WALL-BUSHING TYPE

Current transformers for indoor service, encapsulated in resin. Toroidal model without primary conductor for installation as a wall bushing.

RANGE

- › Insulation voltage up to 36 kV.
- › Rated primary currents up to 8,000 A.
- › Secondary currents: 1 and 5 A.
- › Frequencies: 50 Hz, 60 Hz.

APPLICATIONS

- › Medium voltage air insulated primary distribution switchgears.
- › Power generation.

ADVANTAGES

- › Several inner window diameters.
- › Stainless steel screws, bolts and nuts available.



› Model ABE



› Model ABD

1. VOLTAGE TRANSFORMERS > Generator / Wall-bushing type

MARKING

> SINGLE PRIMARY RATIO AND ONE SECONDARY



> DOUBLE PRIMARY RATIO BY SECONDARY TAPPING AND ONE SECONDARY



> SINGLE PRIMARY RATIO AND TWO SECONDARIES



> SINGLE PRIMARY RATIO AND THREE SECONDARIES

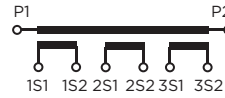

> SINGLE PRIMARY RATIO AND TWO SECONDARIES WITH TAPS



Electrical characteristics

Model	Highest voltage (kV)	Rated insulation level		Maximum primary current (A)	Short-circuit current I_{th}		Maximum number of cores
		Power frequency (kV)	Lightning impulse (BIL) (kVp)		I_{th} (kA/1s)	I_{din} (kA)	
ABD-7	7.2	20	60	4000	100	$2.5 \times I_{th}$	3
ABD-12	12	28	75	4000	100	$2.5 \times I_{th}$	3
ABD-17	17.5	38	95	4000	100	$2.5 \times I_{th}$	3
ABD-24	24	50	125	5000	100	$2.5 \times I_{th}$	3
ABD-36	36	70	170	5000	100	$2.5 \times I_{th}$	3
ABE-12	12	28	75	6000	100	$2.5 \times I_{th}$	4
ABE-24	24	50	125	8000	100	$2.5 \times I_{th}$	4
ABF-24	24	50	125	6500	100	$2.5 \times I_{th}$	3
ABG-24	24	50	125	10000	100	$2.5 \times I_{th}$	3

Subject to technical change.

DIMENSIONS

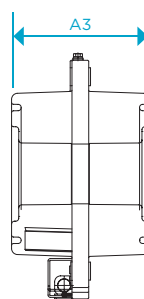
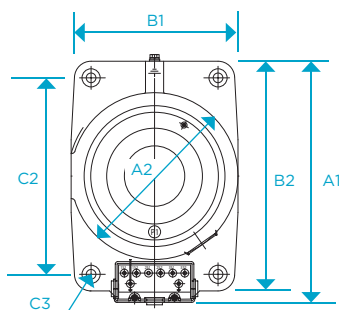

Dimensions and weights

Model	Dimensions (mm)				Base (mm)		Mounting (mm)			Weight (kg)
	Height (A1)	Width (A2)	Length (A3)	Inner diameter (A4)	Width (B1)	Height (B2)	Width (C1)	Height (C2)	Hole diameter (C3)	
ABD-7	400	275	230	100/130	-	-	210	325	16	25
ABD-12	400	275	230	100/130	-	-	210	325	16	25
ABD-17	400	275	230	100/130	-	-	210	325	16	25
ABD-24	425	350	360	150	350	350	305	305	14	55
ABD-36	425	350	540	150	350	350	305	305	14	100
ABE-12	501.5	422	550	275	405	405	360	360	14	100
ABE-24	501.5	422	500	200	405	405	360	360	14	110
ABF-24	613.5	525	180/240	250	-	-	-	-	M16	55
ABG-24	718	625	180/240	3350	-	-	-	-	M16	55

Brass M5/M6 secondary terminals. Zinc-plated, bichromated steel M8/M12 earth terminals. Polycarbonate secondary terminal cover. Zinc-plated, bichromated steel covers available on request. Approximate dimensions and weights.

TOUCH-PROOF TYPE

Resin-cast transformers with metallic coating for installation in medium voltage switchgears insulated in gas.

RANGE

- › Insulation voltage up to 52 kV.
- › Rated primary currents up to 2000 A.
- › Secondary currents: 1 and 5 A..
- › Frequencies: 50 Hz, 60 Hz.

APPLICATIONS

- › Medium voltage primary distribution gas insulated switchgears (GIS).

ADVANTAGES

- › Possibility of secondary currents different from the standardized ones (1 and 5 A).
- › Possibility of frequencies different from the standardized ones (50 and 60 Hz).
- › Stainless steel screws, bolts and nuts available.

ARTECHE instrument transformers are installed in over 150 countries.

WALL BUSHING WITH PRIMARY BAR TYPE

Current transformers for indoor service, encapsulated in resin. Toroidal type with primary conductor to be installed as wall bushings.

RANGE

- › Insulation voltage up to 72.5 kV. Higher voltages also available.
- › Rated primary currents up to 3000 A.
- › Secondary currents: 1 and 5 A..
- › Frequencies: 50 Hz, 60 Hz.

APPLICATIONS

- › Distribution substations.

ADVANTAGES

- › Wall bushings for indoor-indoor or indoor-outdoor installations.
- › Stainless steel screws, bolts and nuts available.



› Model APL

1. VOLTAGE TRANSFORMERS > Touch-proof type

MARKING

> SINGLE PRIMARY RATIO AND ONE SECONDARY

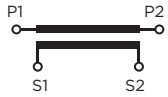

> DOUBLE PRIMARY RATIO BY SECONDARY TAPPING AND ONE SECONDARY



> SINGLE PRIMARY RATIO AND TWO SECONDARIES



> SINGLE PRIMARY RATIO AND THREE SECONDARIES

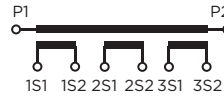

> SINGLE PRIMARY RATIO AND TWO SECONDARIES WITH TAPS



Electrical characteristics

Model	Highest voltage (kV)	Rated insulation level		Maximum primary current (A)	Short-circuit current I_{th}		Maximum number of cores
		Power frequency (kV)	Lightning impulse (BIL) (kVp)		I_{th} (kA/1s)	I_{din} (kA)	
APL-12	12	28	75	3000	100	$2.5 \times I_{th}$	3
APL-36	36	70	170	3000	100	$2.5 \times I_{th}$	3
APL-72	72.5	140	325	3000	100	$2.5 \times I_{th}$	3

Subject to technical change.

DIMENSIONS

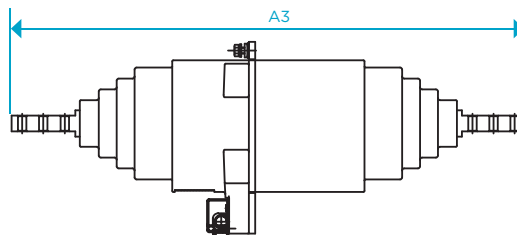
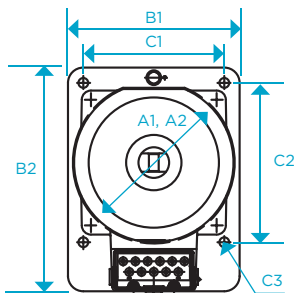

Dimensions and weights

Model	Dimensions (mm)				Base (mm)		Mounting (mm)			Weight (kg)
	Height (A1)	Width (A2)	Length (A3)	Inner diameter (A4)	Width (B1)	Height (B2)	Width (C1)	Height (C2)	Hole diameter (C3)	
APL-12	245	245	675	-	290	290/400	240/175	240/360	16	44
APL-36	260	260	975	-	280	365	230	260	16	85
APL-72	260	260	1530	-	280	365	230	260	16	95

Brass M5/M6 secondary terminals. Zinc-plated, bichromated steel M8/M12 earth terminals.
 Polycarbonate secondary terminal cover. Zinc-plated, bichromated steel covers available on request.
 Approximate dimensions and weights.



> Indoor/outdoor wall-bushing in a distribution substation.