



# B.E.G. LUXOMAT® PD4-M-2C-DS

## Installation and Operating Instruction for B.E.G. – Occupancy detector PD4-M-2C-DS-FC

### 1. Product information

For an increased reliability of the illumination system the PD4-M-2C-DS can be connected to two separate circuits of the alternating current network.

Thus, the illumination system can be divided into two electrically isolated groups, thereby reducing the risk of total failure of the illumination system importantly.

The convenience of a shared pushbutton for both groups is preserved based on the fact that the pushbutton is also electrically isolated.

### 2. Safety note

**!** Work on the 230V mains supply may only be carried out by qualified professionals or by instructed persons under the direction and supervision of qualified skilled electrical personnel in accordance with electrotechnical regulations.

**!** Disconnect supply before installing!

**!** The device is not suited for safe disconnection of the mains supply.

**!** Attention: Both the switch push buttons and the (-) - and (+) - clamps must not be connected to the supply voltage! The pushbutton is supplied directly from the device.

### 3. Installation of the PD4-M-2C-DS

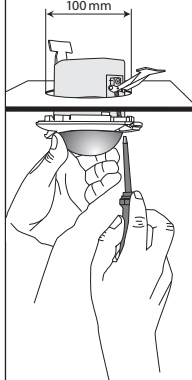

A circular opening of diameter 100 mm must first of all be produced in the ceiling.

Having connected up the cables in accordance with regulations, the detector is inserted into the opening as shown in the drawing opposite and fixed into position with the assistance of the spring clip.

When in Master/Slave mode of operation, the Master-appliance must always be installed at the location where there is least daylight.

### 4. Hardware configuration

Position LED's

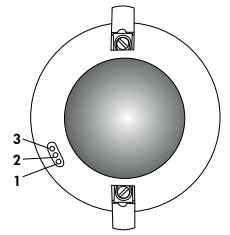

- 1 LED red
- 2 LED green
- 3 LED white

### 5. Hardware configuration

Position Potentiometer and DIP-switch

- DIP1 VA/HA Potentiometer 1 Time
- DIP2 Master/Slave Potentiometer 2 Lux
- DIP3 Corridor mode/standard mode

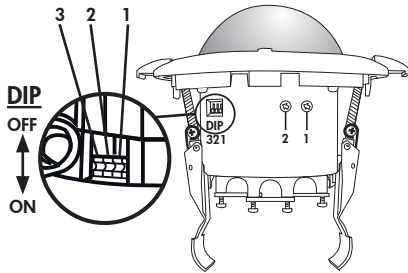

The DIP switch settings are overridden using the remote control.

### 6. DIP switch functions

DIP-switch	ON	OFF
1	Semi-automatic mode	Full automatic mode
2	Slave	Master
3	Standard mode	Corridor mode

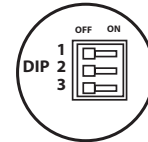

**Corridor function:** After deactivation by an external push button, the detector switches off and returns to automatic mode after 5 sec.

The DIP settings are enabled again by:

- Adjusting the DIP switches when closed
- Reset with test sun setting at the potentiometers
- Reset when open

**Semi-automatic mode/Full automatic mode:** see pt. 16

### Slave function

When using the detector as slave device it sends a data telegram to the master device upon each detection of motion, disregarding ambient luminosity.

### 7. Putting into operation / Settings

#### Self test cycle

After an initial 60-second self-test cycle, the LUXOMAT® PD4-M-2C-DS is ready for operation.



#### Potentiometer 1 - Adjustment follow-up time "Light"

Symbol TEST: Test mode, reacts on motion only. Every movement switches on the light for a period of 2 seconds, switching it off for a period of 2 seconds. The time can be set infinitely variably at between 15 sec. and 60 minutes.



#### Potentiometer 2 - Adjustment twilight-switch

The switch-on value for the light can be set at between 10 and 2000 Lux. Using the potentiometer, the luminance set points can be set as desired.

- Symbol ☾: Night operation
- Symbol ☀: Day/Night operation

#### Determining the current brightness

Set potentiometer 1 to the "Test" setting. The green LED lights up permanently as soon as the value set at the potentiometer 2 exceeds the current measured brightness.

The potentiometer settings are valid for both switching channels. They are overridden using the remote control.

### 8. Reset and default settings

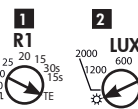

#### 1. Default settings

If the potentiometers are in the "Test" and "Sun" position and the detector is unprogrammed, the factory program is activated: 500 lux and 10 min.

#### 2. Reset

If both potentiometers are returned to the "Test" and "Sun" setting from any other position, a reset is executed. All values programmed with the remote control are deleted.

### 9. Putting into operation of the remote control IR-PD-1C (optional)

#### Check Battery:

Open battery compartment by pressing the plastic springs together and removing the battery-holder.

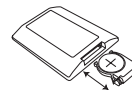

**Caution:** Settings with remote control supersede the settings by potentiometers.

### Option: Remote control IR-PD-1C

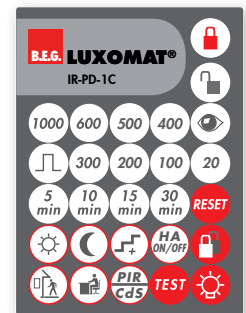

#### Wall bracket for remote control IR-PD-1C

By means of this remote control all settings of the presence detector can be made comfortably from the ground. A useful wall bracket is included in delivery.

## 10. Settings with remote control IR-PD-1C in opened state

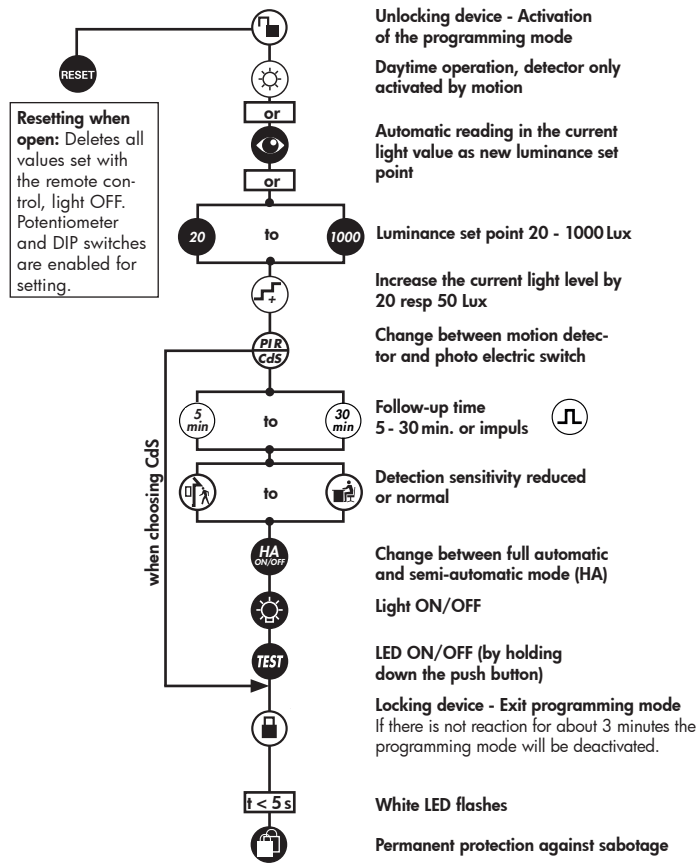

## 11. Key functions in closed state

- Permanent protection against sabotage**  
This function blocks the unit permanently. This operating mode can only be activated during the period of 5 seconds (white LED flash) after pressing the "lock" button. The procedure for leaving this mode is as follows:
  1. Switch off the current
  2. Apply current for 31 - 59 seconds
  3. Switch off the current again
  4. Apply current, wait for selftest cycle
  5. Open detector
- Light ON/OFF during the detection of motion plus follow-up time; Activation of the 12 h-ON/OFF-function by holding down the push button**
- Activation/Deactivation of the test function**  
After 3 minutes the test mode will be automatically closed.
- Switches channel off and is immediately active again, exits all timers, interruption of light measurement**
- Confirmation**
- Changes to "open" state**

## 12. Explanation of the remote control button functions

### 12a. In the initialisation period

- 12 h Light ON/OFF (party function)**  
Activated by "Light" - push button
- Deactivated by "Reset" - push button (default)
- Corridor function (see pt. 14a)**  
Activated by "outside" - push button
- Deactivate by "inside" - push button (default)
- Forced shutdown (see pt. 14c)**  
Activated by "sun" - push button
- Deactivate by "moon" - push button (default)

### 12b. In opened state

- This push button opens the detector and the following functions can then be programmed.  
**Attention:** The detector is closed automatically:
  - after every voltage recovery
  - after 3 minutes
- Change between full automatic and semi-automatic mode (HA)** see pt. 17
- Adjustment twilight-switch**  
Night operation
- Day operation/ Night operation

- The state changes to "closed".  
In the first 5 seconds, the white LED flashes every 0.5 seconds. During this time, sabotage protection can be activated.
- The device distinguishes between 2 procedures:
  - **Reading in with lighting switched on:**  
The switch-on value is determined automatically.  
Determining the switch-on value:
    1. Press the "eye" push button
    2. Switch off the light (2 seconds later)
    3. Read in the brightness
    4. Switch-on value = Read brightness
  - **Reading in with lighting switched off:**  
When the push button is pressed, the current brightness is specified as the switch-on value. The switch-off value is determined automatically.
  - **Setting a fixed switch-on value:**  
If the brightness has been modified, the switch-off threshold is recalculated.

Each time the push button is pressed, the device increases the current switch-on value in increments of 20 lux for a current switch-on value of < 100 lux and in increments of 50 lux for a current switch-on value of > 100 lux.

- Standard sensitivity for most applications
- Reduced sensitivity for outdoor applications
- When the pulse function is active, a pulse of 1 sec. is generated every 9 sec. If the pulse function is activated via remote control, the pause between 2 pulses can be modified. After activating the function via the "Pulse" push button, select the desired time within 5 sec.:  
 $\left(\frac{5}{\text{min}}\right) = 9 \text{ sec.}, \left(\frac{10}{\text{min}}\right) = 10 \text{ sec.}, \left(\frac{15}{\text{min}}\right) = 15 \text{ sec.}, \left(\frac{30}{\text{min}}\right) = 30 \text{ sec.}$
- The "Test" push button can be used to set the LED ON/OFF function. To do this, hold down the push button for 3 sec.  
**Please note** that in the open state and in test mode, the LED indicators are always ON.
- Twilight switch function (Cds)**  
If the Cds function is active, the detector acts as a simple twilight switch. Only the brightness can be set in this mode. Movements are no longer indicated by the red LED.
- Push button acknowledgement:**  
Each push of a button is indicated by lamp acknowledgement and by the white LED.  
"Light ON" status: OFF/ON (approx. 0.5 sec. each)  
"Light OFF" status: ON/OFF (approx. 0.5 sec. each)

## 13. Switch-off threshold brightness

- If the switch-on threshold has been modified by the potentiometer or remote control, the switch-off threshold stored in the EEPROM is deleted and is then recalculated on the next activation.  
Determining the switch-off value
  1. Switch on for 5 min. with dark and motion
  2. Light OFF for 2 sec.
  3. Internal calculation of the switch-off value
- If the eye push button is pressed, the switch-off threshold is recalculated. See also Remote control-> Eye section
- Switch-off delay  
If the determined switch-off threshold is exceeded during operation, the detector only switches off after a delay of approx. 15 minutes. This compensates for any brief fluctuations in the brightness.

## 14a. Behaviour of external push button/IR "Light"

A long button press is supported by devices in master configuration.  
The "Corridor" and "Light ON/OFF" functions are mutually exclusive. If both are activated, the detector performs the corridor function.  
The behaviour when the push button is pressed is defined as follows:

### Corridor function activated

**Light ON:**  
Push button pressed briefly: Light OFF -> Active again after 5 sec.  
Push button held down: Light OFF -> Active again after 5 sec.

**Light OFF:**  
Push button pressed briefly: Light ON as long as motion + Lag time  
Push button held down: Light ON as long as motion + Lag time

## 14b. Behaviour of external push button/IR "Light"

### 12 h Light ON/OFF activated

**Light ON:**  
Push button pressed briefly: Light OFF -> Active after 5 sec.  
Push button held down: 12 h OFF

### Light OFF:

Push button pressed briefly: Light ON as long as motion + Lag time  
Push button held down: 12 h ON

### 12 h Light ON/OFF deactivated

**Light ON:**  
Push button pressed briefly: Light OFF as long as motion + Lag time  
Push button held down: Light OFF as long as motion + Lag time

### Light OFF:

Push button pressed briefly: Light ON as long as motion + Lag time  
Push button held down: Light ON as long as motion + Lag time

## 14c. Behaviour of external push button/IR "Forced shutdown"

### Forced shutdown active

**Light OFF:**  
Light OFF: Push button pressed briefly: Light ON for approx. 30 min., then forced shutdown if the set brightness is still exceeded.

## 15. Other functions

### Activation of light for 12h via mains interruption

1. Interrupt current of both supply lines
2. Apply current for 2 to 5 sec.
3. Interrupt current again
4. Apply current
5. Detector is now ON for 12h

### Exiting sabotage

1. Interrupt current of both supply lines
2. Apply current for 30 to 60 sec.
3. Interrupt current again
4. Apply current
5. Detector is in simple closed state

## 16. Full automatic and semi-automatic mode

(see functions IR-PD-1C)



### Full automatic operation

In this operating mode, the lighting switches automatically on and off for increased comfort, depending on presence and brightness.

- Channel 1 switches on in the event of motion if "dark" is detected.

### Semi-automatic operation

In this operating condition, in order to gain increased savings, the lighting is energized only after being manually switched on.

Switch-off takes place automatically or manually.

The semi-automatic mode basically behaves like the full automatic one. However, the difference is that switching-on must always be carried out manually!

As many (closer-contact) buttons as desired can be wired in parallel on the "S" button input (ON/OFF).

**Triggering in semi-automatic mode:** If the detector switches off in semi-automatic mode (lag timer elapsed), the detector is switched on again within 10 sec. by motion (despite semi-automatic mode).

## 17. Range of Coverage

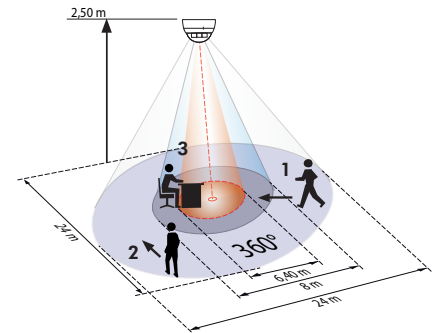

PD4-M-2C-DS

- 1 walking towards
- 2 walking across
- 3 seated

## 18. Exclude sources of interferences

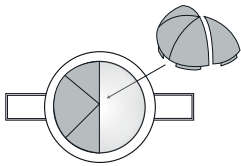

In case the sensing area of the LUXOMAT® PD4-M-2C-DS is too large or areas are being covered that should not be monitored, the range can be reduced or limited through use of the enclosed masking clips.

## 19. Article / Part nr. / Accessory

Type	FC
PD4-M-2C-DS (Master and Slave)	92760

### LUXOMAT® Remote control:

IR-PD-1C (incl. wall bracket) 92520

### Accessory:

BSK Ball basket guard 92199

Wall bracket for remote control as replacement 92100

## 20. Technical data PD4-M-2C-DS

Sensor and power supply in one case

**Power supply:** 230V~ ±10%

**Buffering period of tension:** 200 ms

**Power consumption:** < 1 W

**Ambient temperature:** -25°C to +50°C

**Degree of protection/class:** IP20 / II

**BUS and pushbutton connections:** screened cable: 0.28 mm<sup>2</sup>

maximum cord length: 30 m

**Settings:** Potentiometer, DIP-switch and by remote control

**Light values:** 20-1000 Lux by remote control

10-2000 Lux by potentiometer

**Extension of the detection area:** with max. one device in slave-configuration

**Area of coverage:** circular 360°

**Range of coverage Ø H 2,50 m / T = 18°C:**

seated 6,40 m / tangential 24 m / radial 8 m

**Recommended height for mounting:** 2 - 3 m

**Light measurement:** daylight + artificial light

• Power switch for light (both circuits)

**Type of contact:** NOC/with pretravel tungsten contact

**Contact load:** 2300 W cos φ=1 / 1150 VA cos φ=0.5, μ-Contact

**Time-settings:**

15 sec. - 60 min./ test with potentiometer

5 min. - 30 min./ test with remote control

**Dimension:** PD4-M-2C-DS-FC H 100 x Ø 117 mm

**Visible portion when built into ceiling FC:** H 37 x Ø 117 mm

### EU Declaration of Conformity:



This product respects the directives concerning

1. electromagnetic compatibility (2014/30/EU)
2. low voltage (2014/35/EU)
3. restriction of the use of certain hazardous substances in electrical and electronic equipment (2011/65/EU)

## 22. Operation manual

The PD4-M-2C-DS has a common optical system for both outputs. The device gets its operating voltage from both phases. If L2 fails, the device is operated with L1 and vice versa. L1' closes only if L1 is connected and L2', closes only if L2 is connected.

## 21. Wiring diagram

Standard mode with master (2 alternating current circuits) and pushbutton as well as one device in slave-configuration

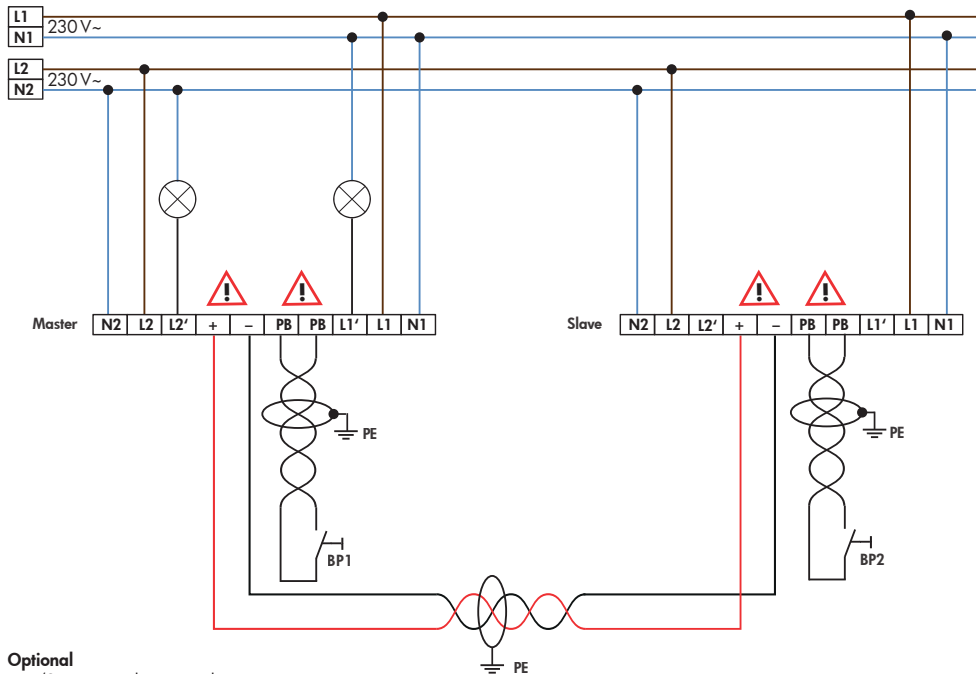

### Optional

PB1/2 = optional sensing device;

Slave = PD4-M-2C-DS in slave configuration

### 23. PD4-M-2C-DS-FC - Connection

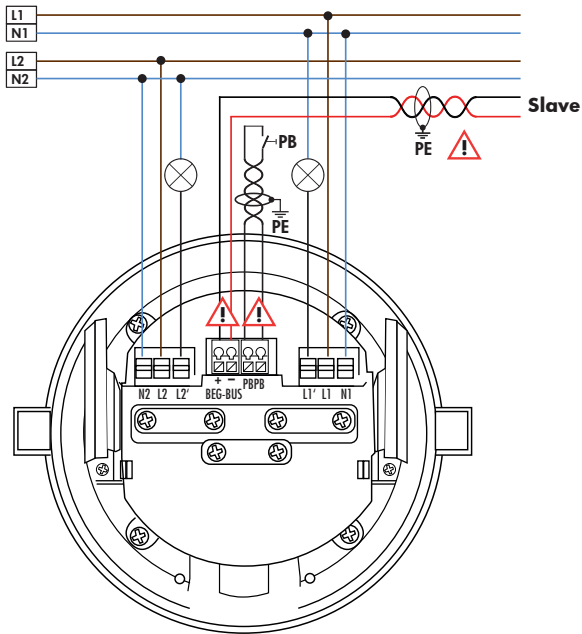

**Optional**  
PB = optional button;  
Slave = Device in slave configuration

### 24. LED function indicators in master-configuration (default)

LED function indicators after each mains recovery (60 sec. initialisation period)			
Operating state	LED function indicators		
Factory program active	White, red and green flash in quick succession for 10 sec., then initialisation indicators, see below		
Double-locked	White and green shines for 5 sec. all 20 sec., afterwards initialising notification		
	Indicator unprogrammed	Indicator programmed	Indicator also when forced shutdown is activated
Standard mode	Red flashes	Red flashes quickly	Every 5 sec., 4 x white, red and green in quick succession
12 h ON/OFF active	Red and green flash	Red and green flash quickly	Every 5 sec., 4 x white, red and green in quick succession
Corridor active	Red and white flash	Red and white flash quickly	Every 5 sec., 4 x white, red and green in quick succession
12 h ON/OFF & corridor active	Red, green and white flash	Red, green and white flash quickly	Every 5 sec., 4 x white, red and green in quick succession
CdS active	–	Red and white flash	Then <u>no</u> red LED for motion detection

LED function indicators during operation	
Process	LED function indicators
Motion detection	Red flashes on each detected movement
Semi-automatic mode active	White is ON
Impulse active	Red and green flash one time all 4 sec.
Corridor active	White ON 1 sec. and OFF 4 sec.
Corridor and semi-automatic mode active	White ON 4 sec. and OFF 1 sec.
Too bright detected	Green flashes
Light measurement active	Green flashes once every 10 sec.
12 h ON/OFF function active	Red and green flash alternately
Duration ON active (by slave)	Red flashes quickly
IR command	White flashes once
IR command „Open“ and sabotage active	White and green flash once slowly

### 24. LED function indicators in slave-configuration

LED function indicators during operation	
Incident	Function indicator LED
Error indicator - defective master-slave communication	Permanent red light
Motion detection	Green flashes when motion is detected
Error indicator - connection error BEG bus	Permanent red and white light