

MAXTHERMO-GITTA GROUP CORP MAXIMUM ELECTRONIC CO., LTD

Temperature PID Controllers

OPERATIONAL MANUAL

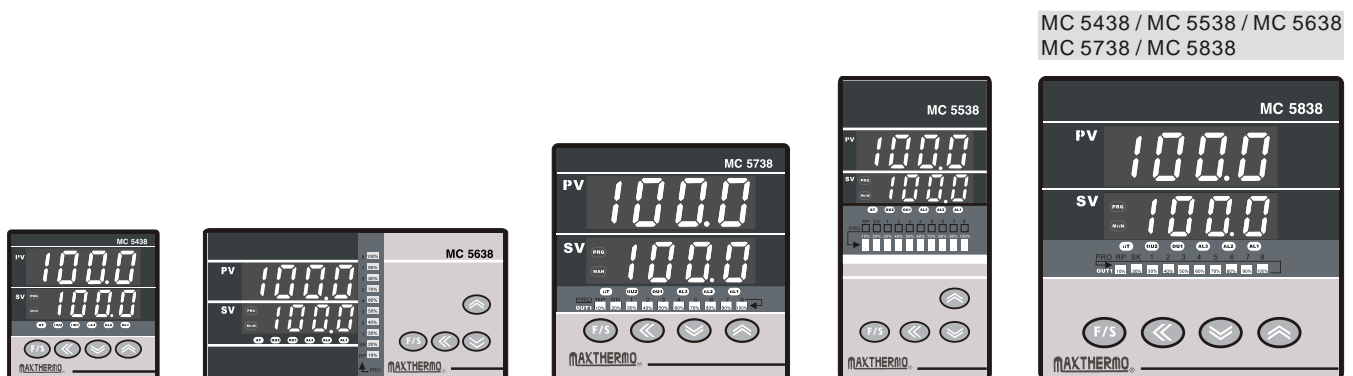

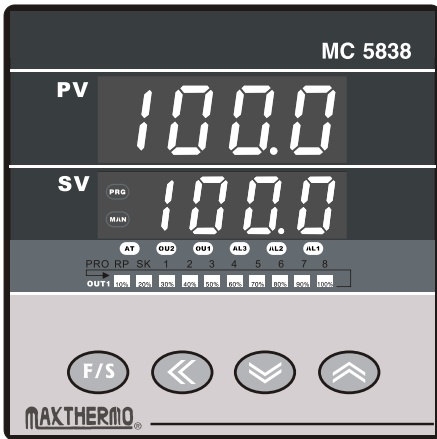

Display unit & Indication lamps

PV	= Measured value display
SV	= Set value display
AL1	= Alarm 1 output lamp
AL2	= Alarm 2 output lamp
AL3	= Alarm 3 output lamp
OU1	= Control output 1 lamp
OU2	= Control output 2 lamp
AT	= Autotuning lamp
MAN	= Manual mode lamp
10% ~ 100%	= Manipulated output value display
PRG	= Programmable mode lamp
1-8	= Segment-in-process display lamp
RP	= Ramping mode lamp (programmable mode only)
SK	= Soaking mode lamp (programmable mode only)

Operation keys

F/S	= Function & Set key
←	= Shift key
↓	= Down key
↑	= Up key
↑ (3 sec)	Press 3 sec while the SV is not flashing = Used for returning to initial window
↓ (3 sec)	Press 3 sec while in level selection window = Used for calling up lock function
↓ (3 sec)	Press 3 sec while in pv/sv initial window = Used for stopping output and SV window will display "HOLD", ↓ (3 sec) press 3 sec again to regain output (This function is available only while OUTM is selected 1 or 2)
F/S (3 sec)	Press 3 sec while in pv/sv initial window = Used for calling up level selection
F/S (3 sec)	Press 3 sec while in level selection window = Used for entering each level

Operation keys (programmable mode only)

These keys are only operated in PV/SV initial window	
↑ (3SEC) Run	PRG lights, RP or SK flashes The executing segment lamp lights
↓ (3SEC) Pause	PRG, RP and SK light The executing segment lamp lights
↑ + F/S Jump	Jump to the next segment, press ↑ first
↓ + F/S Stop	Turn off all lamps which used for programmable mode, press ↓ first
Refer to arrow When PRG Lights (No PRG light in MC-5438)	

Parameter	DESCRIPTION	RANGE	Initial value
<i>PV</i> Pv	Process value	LoSP~HiSP	
<i>SV</i> Sv	Set value	LoSP~HiSP	0.0

USER ▼

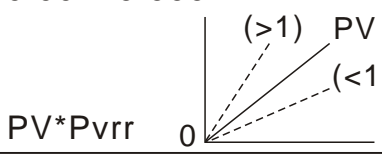
<i>OutL</i> OutL	Output percentage	0.0~100.0%	0.0
<i>At</i> At	Auto tuning	No / yes	no
<i>Man</i> Man	Manual mode	Man1 =power failure memory Man2 =no memory No =non	no
<i>AL1S</i> AL1S	Alarm 1 set value	If ALIF set at 1 or 2 range=-200~200 If ALIF set at 3 or 4 range=LoSP~HiSP If ALIF set at 10 range =1-8 segment ending	10.0
<i>AL1L</i> AL1L	Alarm 1 lower set value	0~200	10.0
<i>AL1u</i> AL1u	Alarm 1 upper set value	0~200	10.0
<i>AL2S AL3S</i>	AL2S / AL3S For operating functions refer to the above descriptions		
<i>SoAK</i> SoAK	Perform only when AL1M set at 8 or9 refer to explanation on page 7	0.00~99.59 (h.m)	0.00
<i>rAmP</i> rAmP	Ramp refer to explanation on page 7	0.0~200.0/m	0.0
<i>Pvof</i> Pvof	Pv offset refer to explanation on page 7	-200~200	0.0
<i>Pvrr</i> Pvrr	Pv ratio refer to explanation on page 7	0.001~9.999 	1.000
<i>SvoF</i> SvoF	Sv offset refer to explanation on page 7	-200~200	0.0
<i>Ct</i> Ct	Current transformer monitor refer to explanation on page 7	0.0~100.0A	
<i>HbA</i> HbA	Heater break alarm value refer to explanation on page 8	0.1~100.0A	0.1
<i>LbA</i> LbA	Control loop break alarm time refer to explanation on page 8	0.1~200.0 min	8.0
<i>Lbd</i> Lbd	LBA dead band refer to explanation on page 8	0.0~200.0	0.0
<i>rPtm</i> rPtm	Repeat times monitor Only use in program function refer to explanation on page 8	1~1000	

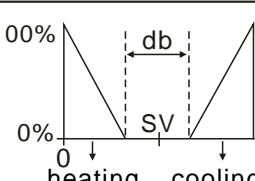
Parameter	DESCRIPTION	RANGE	Initial value
Ctrl ▼			
<i>P1</i> P1	Output 1 proportional band	0.0~3000	30.0
<i>i1</i> i1	Output 1 integral time	0~3600 sec	240
<i>d1</i> d1	Output 1 derivative time	0~900 sec	60
<i>Ct1</i> Ct1	Output 1 cyclic time refer to explanation on page 8	0~150 sec	15
<i>HSt1</i> HSt1	Output 1 hysteresis	0.0~200.0	0.0
<i>AtoF</i> AtoF	At offset refer to explanation on page 8	-200~200	0.0
<i>Ar</i> Ar	Anti-reset windup refer to explanation on page 8	0~100.0% SV-P1 x Ar	100.0
<i>P2</i> P2	Output 2 proportional band	0.0~3000	30.0
<i>i2</i> i2	Output 2 integral time	0~3600 sec	240
<i>d2</i> d2	Output 2 derivative time	0~900 sec	60
<i>Ct2</i> Ct2	Output 2 cyclic time	0~150 sec	15
<i>HSt2</i> HSt2	Output 2 hysteresis	0.0~200.0	0.0
<i>db</i> db	Dead band/overlap	-200.0~200.0 	0.0
<i>SSv</i> SSv	Soft start set value refer to explanation on page 8	0.0~200.0 (see fig 2)	120.0
<i>Sout</i> Sout	Soft start output percentage refer to explanation on page 8	0.0~100.0% (see fig 2)	30.0
<i>StmE</i> StmE	Soft start failed time refer to explanation on page 8	0~10 min (see fig 2)	10
<i>ruCy</i> ruCy	Motor valve cyclic time refer to explanation on page 8	1~150 sec (see fig 3)	5
<i>rPt</i> rPt	Program executing times refer to explanation on page 8	1~1000 (see fig 4)	1
<i>StAt</i> StAt	Start mode selection use in program function only refer to explanation on page 8	CoLd = manual rSEt=start after power ON Hot= start from memory of power failure	CoLd
<i>PvSt</i> PvSt	Start point selection use in program function only	RSEt = start from 0 Pv = start from PV	rSEt
<i>wAit</i> wAit	Wait value in program refer to explanation on page 8	0.0~200.0	0.0
<i>Pid</i> Pid	PID/Level PID selection refer to explanation on page 9	Pid =Pid Lpid =Level Pid	Pid
<i>EndP</i> EndP	Selects control when program ended refer to explanation on page 9	Cont = Continue StoP =One program only (see fig 4)	StoP

Parameter	DESCRIPTION	RANGE	Initial value
Out ▼			
<i>AL 1F</i> AL1F	Alarm 1 action function	0~12 (see table 1)	1
<i>AL 1H</i> AL1H	Alarm 1 hysteresis	0.0~200.0	0.0
<i>AL 1t</i> AL1t	Alarm 1 in program mode on time	0.00~99.59 (h~m)	0.00
<i>AL 1m</i> AL1m	Alarm 1 special mode selection	(see table 2)	0
For operating functions refer to the above descriptions Different function see(1),(2),(3)			
<i>AL 2F</i> AL2F	(1)AL2M Alarm 2 special mode selection (See Table 2)	0~7	
<i>AL 3F</i> AL3F	(2)AL3F Alarm 3 action function (See Table 1)	0~11	
<i>AL 3F</i> AI3F	(3)AL3M Alarm 3 special mode selection (see Table 2)	0~7	
<i>Act</i> Act	Control action selection	Cool / HEAT	HEAT
<i>Outm</i> Outm	Output mode selection This parameter is skipped, opening it needs to contact distributor (see table 3)		1
<i>O1LS</i> O1LS	Output 1 scale low	0.0~100.0%	17.6
<i>O1HS</i> O1HS	Output 1 scale high	0.0~100.0%	96.0
<i>AO</i> AO	Analog output selection	Pv=transmit PV Sv=transmit SV dEv=transmit (PV-SV) Mv=transmit output percentage	Pv
<i>O2LS</i> O2LS	Output 2 scale low	0.0~100.0%	17.6
<i>O2HS</i> O2HS	Output 2 scale high	0.0~100.0%	96.0
<i>t1SS</i> t1SS	Time signal 1 start segment setting Use in program function only refer to explanation on page 9	1~8	1
<i>t1On</i> t1On	Time signal 1 on time setting Use in program function only refer to explanation on page 9	0.00~99.59 (h~m)	0.01
<i>t1ES</i> t1ES	Time signal 1 end segment setting Use in program function only refer to explanation on page 9	1~8	1
<i>t1oF</i> T1oF	Time signal 1 off time setting Use in program function only refer to explanation on page 9	0.00~99.59 (h~m)	0.01
<i>t2SS</i> t2SS	For operating functions refer to the above descriptions		

Parameter	DESCRIPTION	RANGE	Initial value	
inP ▼				
<i>inP1</i>	inP1	Input 1 selection	(see table 4)	K2
<i>LoSP</i>	LoSP	Low setting limit	LOSP~HiSP	0.0
<i>HiSP</i>	HiSP	High setting limit	LOSP~HiSP	400.0
<i>LoAn</i>	LoAn	Analog input range low refer to on page 21	-1999~9999	0.0
<i>HiAn</i>	HiAn	Analog input range high refer to on page 21	-1999~9999	100.0
<i>A1LS</i>	A1LS	Analog input 1 scale low refer to on page 21	0~FFFF	
<i>A1HS</i>	A1HS	Analog input 1 scale high refer to on page 21	0~FFFF	
<i>unit</i>	unit	Unit selection	~ / ~ /non	~
<i>dP</i>	dP	Decimal point	0/0.0/0.00/0.000	0.0
<i>FiLt</i>	FiLt	Digital filter (see fig 5)	0.001~1.000 Non = no function Ct = use for heater break alarm rmSV= use for remote SV	0.900
<i>inP2</i>	inP2	Input 2 selection		non
<i>A2LS</i>	A2LS	Analog input 2 scale low	0~FFFF	
<i>A2HS</i>	A2HS	Analog input 2 scale high	0~FFFF	
SPC ▼				
<i>bAud</i>	bAud	Baud rate	2.4K / 4.8K / 9.6K 19.2K / 38.4K	9.6K
<i>Addr</i>	Addr	Address	0~31	0
<i>Lev1</i>	Lev1	Set the range for level1 PID (see fig 6) (act only when level PID is selected)	LoSP~HiSP	400
<i>Lev2</i>	Lev2	Set the range for level2 PID (see fig 6) (act only when level PID is selected)	LoSP~HiSP	400
<i>Lev3</i>	Lev3	Set the range for level3 PID (see fig 6) (act only when level PID is selected)	LoSP~HiSP	400
<i>LvSL</i>	LvSL	Watched PID level selection, the level is selected which will display below	1~4 refer to explanation on page 9	1
<i>L1P1</i>	L1P1	Output 1 proportional band for level 1	0.0~3000	30.0
<i>L1i1</i>	L1i1	Output 1 integral time for level1	0~3600 sec	240
<i>L1d1</i>	L1d1	Output 1 derivative time for level1	0~900 sec	60
<i>L1Ar</i>	L1Ar	Anti-reset windup for level1	0.0~100.0%	100.0
<i>L1P2</i>	L1P2	Output 2 proportional band for level 1	0.0~3000 sec	30.0
<i>L1i2</i>	L1i2	Output 2 integral time for level1	0~3600 sec	240
<i>L1d2</i>	L1d2	Output 2 derivative time for level 1	0~900	60
<i>L2P ~ 4</i>	The same as level 1			

Parameter	DESCRIPTION	RANGE	Initial value
Prog ▼			
5EG SEG	Program segment monitor	1~8	
t nE TimE	Program countdown monitor		
EndS EndS	Program segment end setting	1~8	1
541 Sv1	Sv in segment 1 (see fig 7)	LoSP~HiSP	100
tP1 tP1	Program time in segment 1 (see fig 7)	0.00~99.59 (H.M)	0.00
tS1 tS1	Soak time in segment 1 (see fig 7)	0.00~99.59 (H.M)	0.00
542~8	The same as segment 1		
Hide ▼			
1-2~1-22	Parameter shows with respect to this position	non~t2of	
2-14~2-17	Parameter shows with respect to this position	non~t2of	
3-20~3-27	Parameter shows with respect to this position	non~t2of	

PARAMETER EXPLANATIONS

SoAK	It performs only when AL1M set at 8 or 9, and the controller is without program function. If you set AL1M at 8, then AL1 shifts to soak function and contactor is normal open; if you set AL1M at 9, then AL1 shifts to soak function but contactor is normal close.
rAmP	It's for setting that PV will be increased or decreased by set value if the controller is without program function. For example: If rAmP is set at 10 , then the PV will increase 10~ per minute, but if PV is higher than SV, then the PV will decrease 10~ per minute.
PvoF	It's for setting that if PV is not correct to SV, then you can adjust it with (+) or (-).
Pvrr	It's for adjusting PV be more accurate. The formulation is $PV(\text{now}) = PV(\text{pre}) \times Pvrr + PVOF$.
SvoF	It's for setting that if SV is not correct to PV, then you can adjust it with (+) or (-).
Ct	It's for detecting current to find if the heater is broken. Display value:0.0~100.0A. When you order CT function,a small C.T. is included.

HbA	<p>Heater break alarm set value. Set value range: 0.1 ~100.0 A. For Example:</p> <p>a. When Low or no current flow, but control output is On, and $CT \leq HBA$, it means heater is broken, then the alarm is on. a.b. When over current or short-circuit, but control output is off, and $CT \geq HBA$, then the alarm is on. (The CT and HBA parameter works only when you order Heater break alarm function).</p>
LbA & Lbd	<p>They are parameters for Loop Break Alarm. For Example: When Out1:0.0%, LBA time elapsed, PV should be below LBD, if it is still within LBD determination range, alarm is on . When Out1:100.0%, LBA time elapsed, PV should be upper LBD, if it is still within LBD determination range, alarm is on . (LBA and LBD works by software setting, no need to order extra components).</p>
rPtm	<p>It shows how many times of running program at the moment. This parameter works when your PID controller opens on program function.</p>
Ct1	<p>It's for setting ON-OFF cyclic time of output 1, normally it is set at 0 for 4~20Ma output, 1 for SSR drive output, 15 for relay output.</p>
Ar	<p>It's a solution for preventing over-shooting. This parameter makes Integral delay. The setting range is from 0 to 100%, initial value 100% means integral will perform when PV reaches proportional band, but if you set Ar at 50%, it means integral will perform when PV reaches 50% of proportional band.</p>
SSV	<p>It's for setting soft start range, when you want the heating system doesn't go up too quick at the beginning, you may set SSV. For Example: You want the temperature going up slowly under 120°, you may set SSV at 120.</p>
Sout	<p>It is for setting the output percentage under SSV , if you want 50% of output, you may set it at 50 .</p>
StmE	<p>It is for setting soft start failure time. When the PID controller reaches the StmE time, but PV doesn't reach SSV, it means soft start failure, then Controller will revert to SV.</p>
RuCy	<p>Motor valve cyclic time, it means the time from close to open or from open to close.</p>
rPt	<p>It's for setting how many times of program process to be executed.</p>
StAt	<p>It is for setting when it starts program procedure, cold is by manual, Rset is to start after power on. Hot is to start from memory of power failure.</p>
wAit	<p>It is for setting the value that SV will wait PV if PV goes up slowly than SV.</p>

Pid	In this parameter, you can choose the controller with one PID performing only or level-PID (LPID) performing, if you choose LPID then you can set 4 levels of different PID.
Endp	It is for setting when program is ending, one program only or to be continued.
tiSS	t1SS is for time signal alarm to set which segment you want it to start alarm (in program function). For Example: You want it alarms at segment 2, then you may set it to 2 .
tiOn	t1On is to set what time do you want alarm to perform. For Example: You want it alarms at 6 min. (if your segment 2 set at 10 min.), you may set it to 6 , then the alarm will perform in segment 2, but start from 6 th min.
t1Es	t1ES is to set which segment you want to end alarm (in program function). For Example: You want it ends at segment 5, then you may set it to 5 .
T1oF	T1oF is to set what time do you want alarm to end. For Example: You want it ends at 3 min. (if your segment 5 set at 5 min.), you may set it to 3 , then the alarm will end at 3 rd min. of segment 5.
LvSL	LvSL is for level PID use, which level of PID you have set, then you can watch its PID value. For Example: You set it to 3 , then you can watch L3P1, L3I1, L3d1 But in first you need to set Lpid at Pid parameter in level Cntl and Lev1 to Lev 3 in SPC level.

Fig 1. PID Auto Tuning

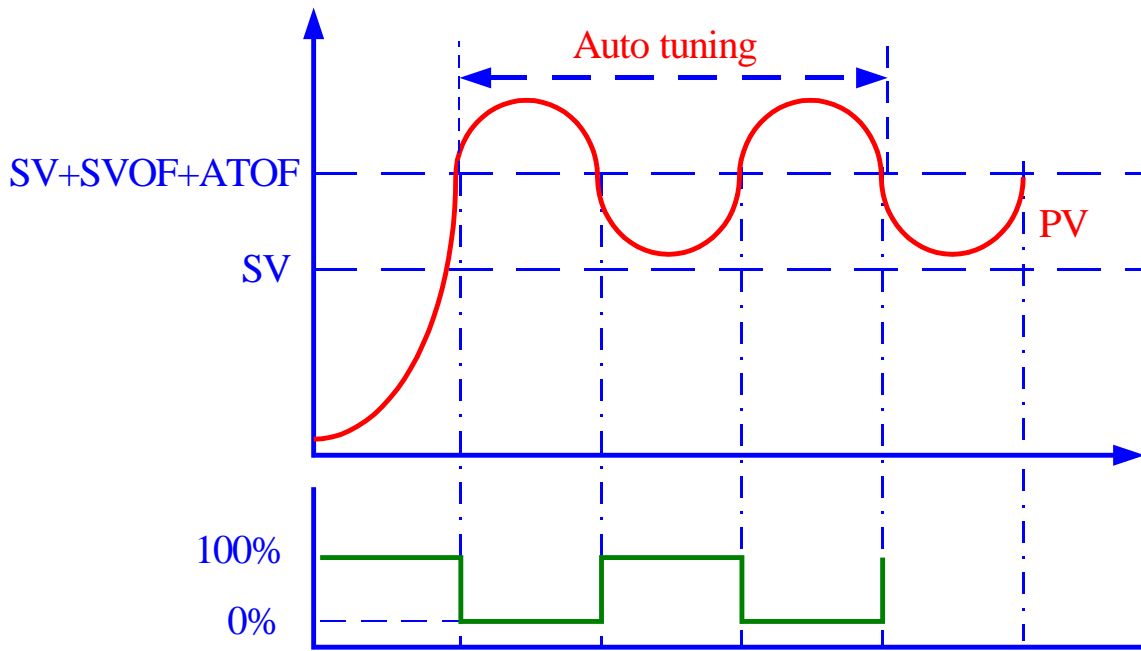

Fig 2. Soft Start

- SSV
Soft start set value
- SOUT
Soft start output percentage
- STME
Soft start failed time

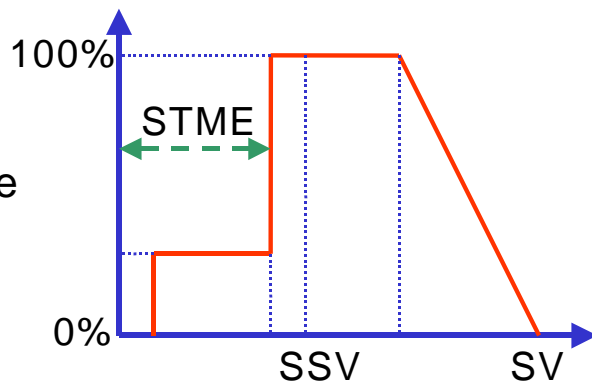
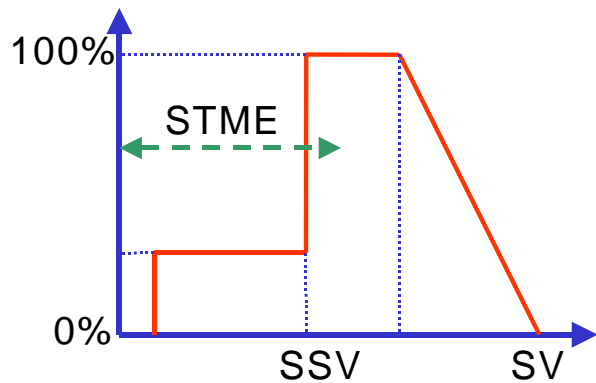

Fig 3. Motor Valve Control

RUCY
Motor valve cyclic time

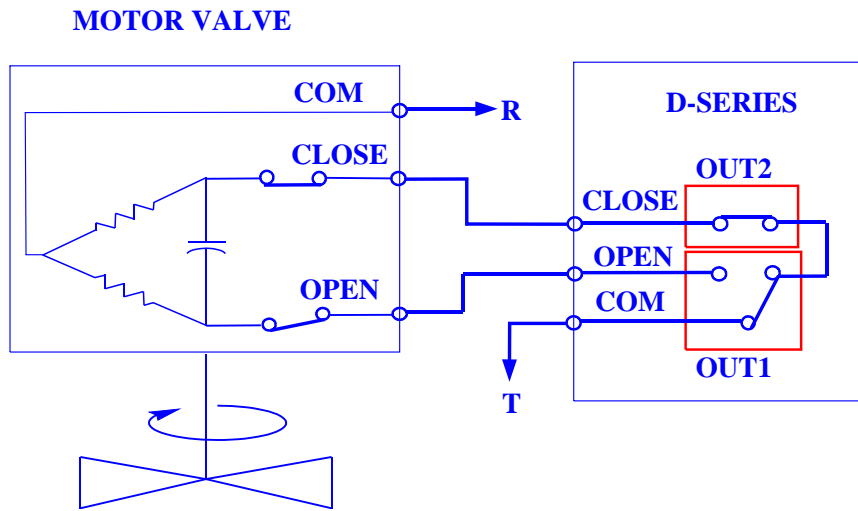

Fig 4. Program Control (Con't)

RPTM	Repeat times monitor
RPT	Program execution times setting
STAT	Start mode selection
PVST	Start point selection
WAIT	Wait zone
ENDP	Selects control when program ended
SEG	Program segment monitor
TIME	Program countdown monitor
ENDS	Program end segment setting

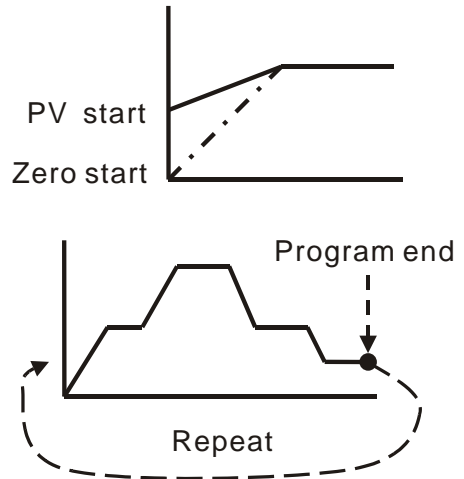

Fig 5. Digital Filter(con't)

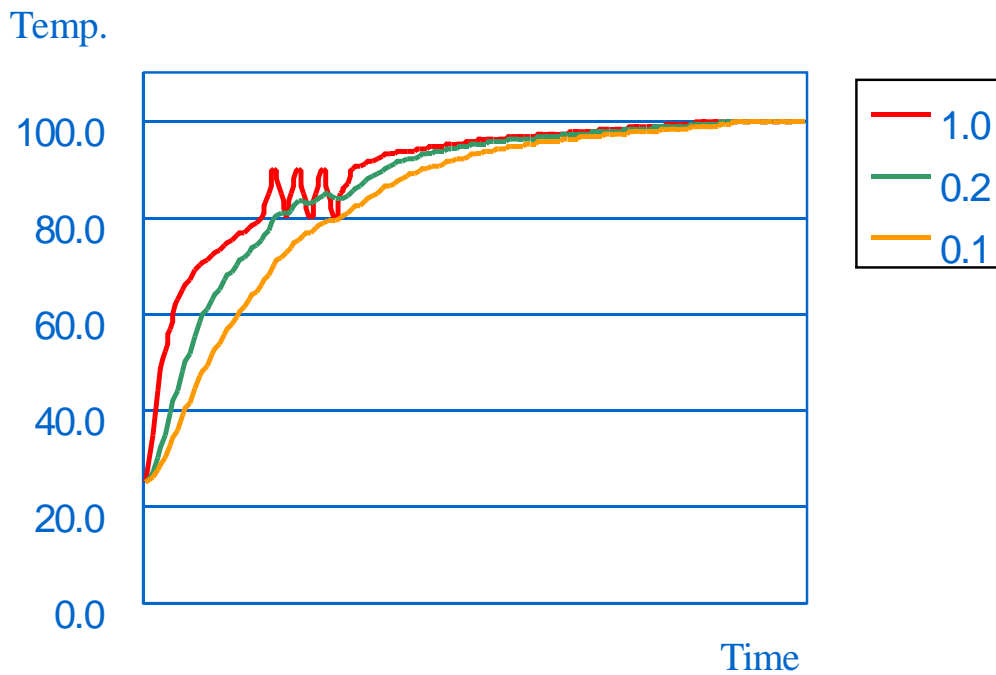

Fig 6. Level PID

PID	PID/level PID selection
LEV1	Level 1
LEV2	Level 2
LEV3	Level 3
LVSL	Levels selection
L1P1	P1 for group 1
L1I1	I1 for group 1
L1D1	D1 for group 1
L1AR	AR for group 1
L1P2	P2 for group 1
L1I2	I2 for group 1
L1D2	D2 for group 1

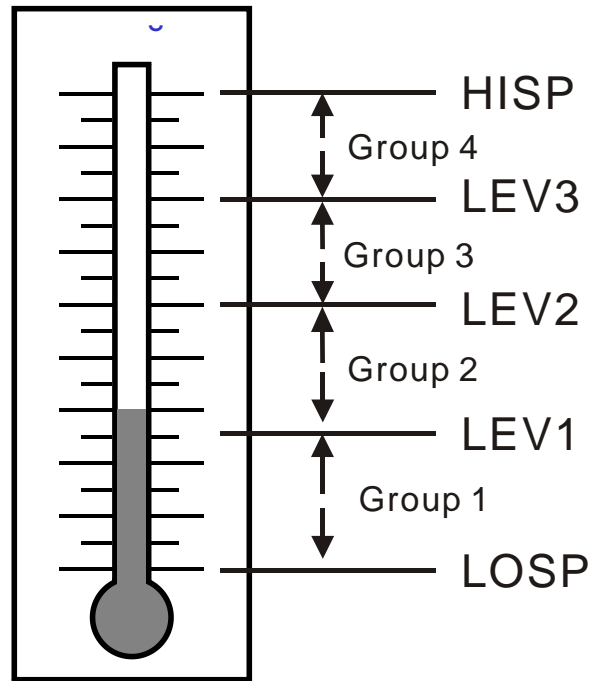

Fig7. Program Control

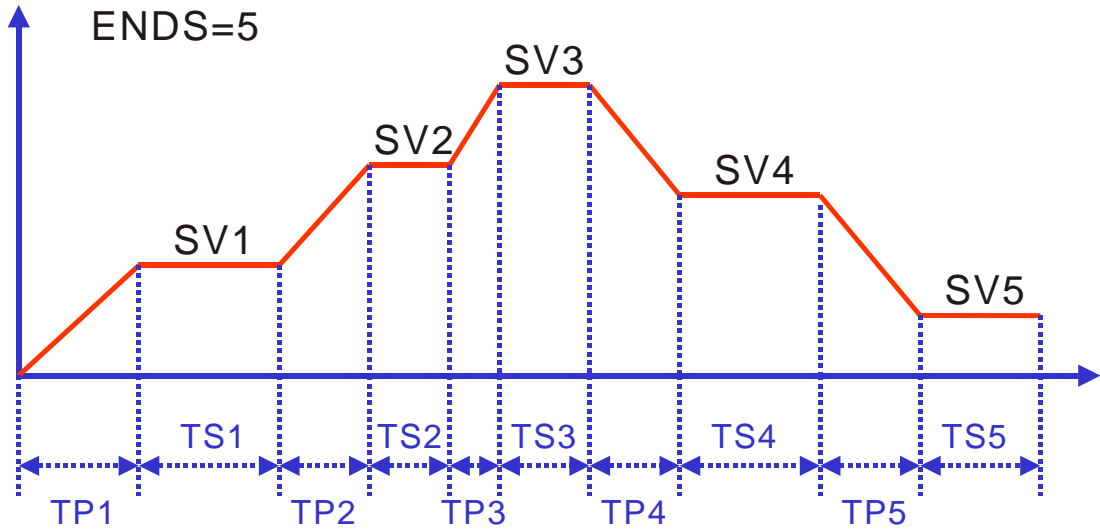

Fig8. Loop Break Alarm

OUTL=0.0%
 LBA time elapsed
 PV is still within
 determination range

OUTL=100.0%
 LBA time elapsed
 PV is still within
 determination range

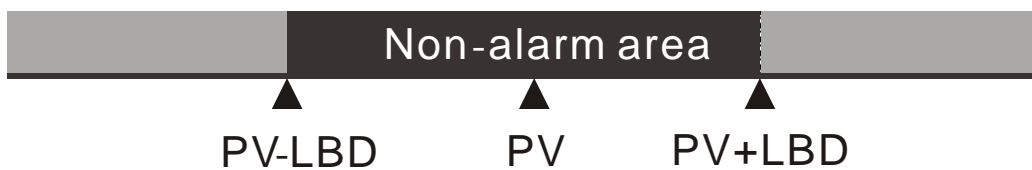

Fig 9. Heater Break Alarm

Low or No current flow
Control output is ON
 $CT \leq HBA$

Over current or short-circuit
Control output is OFF
 $CT \geq HBA$

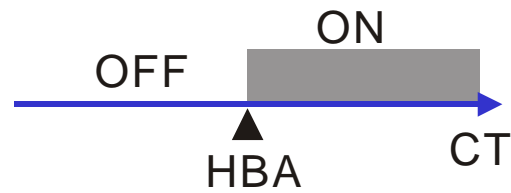
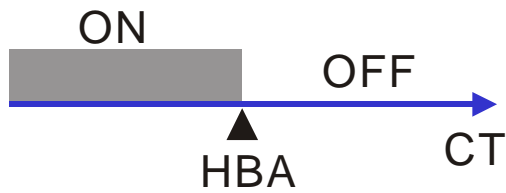

Fig 10. Segment Ending Alarm

AL1F

10

AL1S

1~8 segment

AL1T

0.00

Flicker alarm

99.59

Continued alarm

Others

ON delay time

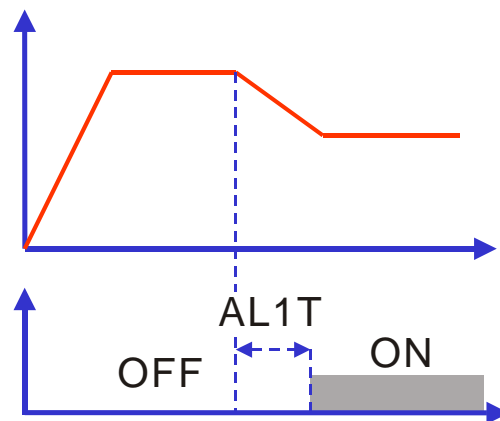

Fig 11. Program Ending Alarm

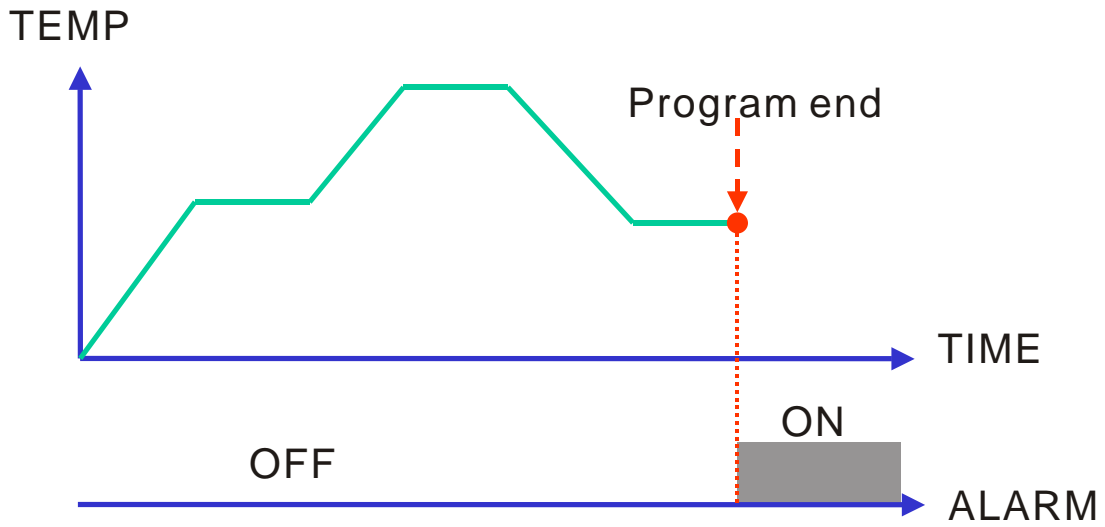

Fig 12. Time Signal Alarm

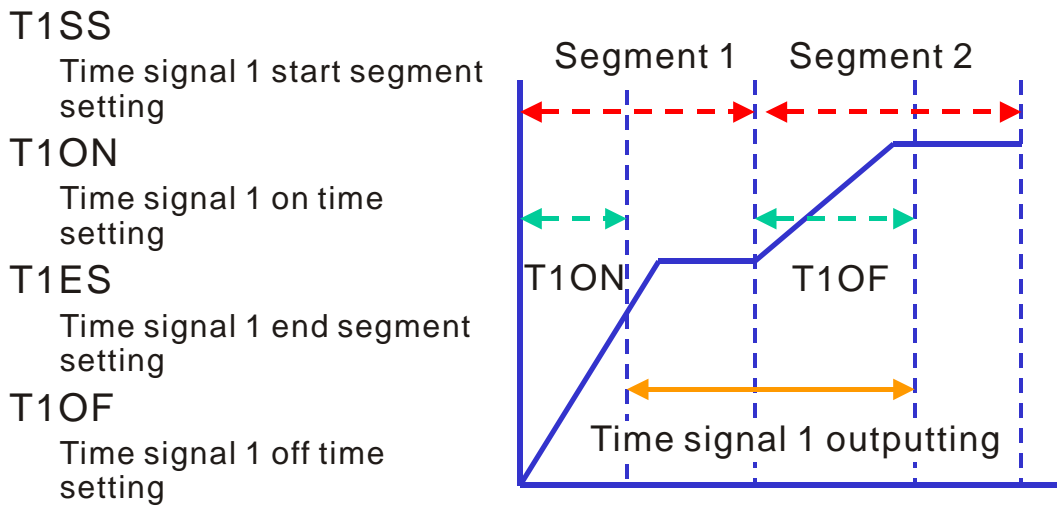

Fig 13. Program Running Alarm

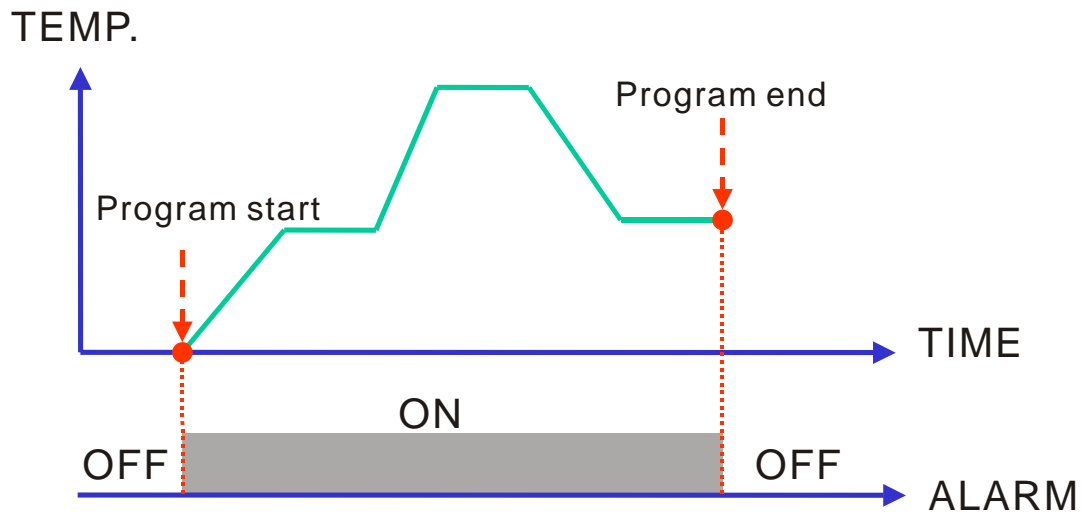

Fig 14. Communication Protocol

Interface

RS-485
RS-232

Baud rate

2400
4800
9600
19200
38400

Data frame

Data Bits=8
Parity = None
Start bit = 1
Stop bit = 1

Data format

ModBus Protocol RTU
Mode

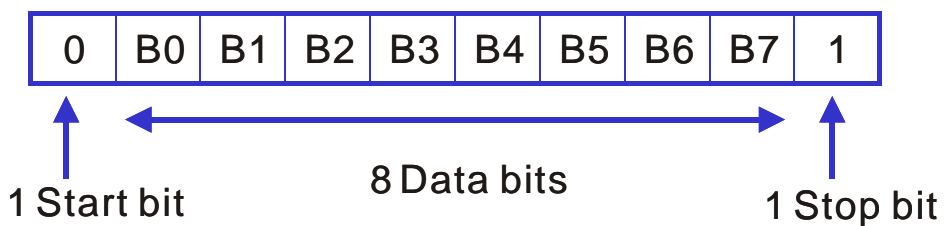

Table 1. Alarm Mode Selection
(Used in Parameter AL1F,AL2F,AL3F)

AL1F	AL2F	AL3F	Alarm function selection	
0	0	0	No alarm	
1	1	1	Deviation high alarm	
2	2	2	Deviation low alarm	
3	3	3	Absolute high alarm	
4	4	4	Absolute low alarm	
5	5	5	Deviation high/low alarm	
6	6	6	Band alarm	
7	7	7	System failure alarm (when error information happen)	
8	8	8	Loop break alarm	see fig 8
9	9	9	Heater break alarm	see fig 9
10	10	10	Segment ending alarm in program control	see fig 10
11	11	11	Program ending alarm in program control	see fig 11
12	12		Time signal alarm	see fig 12
13	13		Program running alarm in program control	see fig 13

Table 4.)used in parameter InP1)
input & temperature ranges selection

TYPE		
K1	0~200	32~392
K2	0~400	32~752
K3	0~800	32~1472
K4	0~1000	32~1832
K5	0~1200	32~2192
j1	0~200	32~392
j2	0~400	32~752
j3	0~800	32~1472
j4	0~1000	32~1832
j5	0~1200	32~2192
t1	-50~50	-58~122
t2	-100~100	-148~212
t3	-200~400	-328~752
r	0~1700	32~3092
E	0~1000	32~1832
S	0~1700	32~3092
b	0~1800	32~3272
n	-200~1300	-328~2372
Pt1	-50~50	-58~122
Pt2	0~100	32~212
Pt3	0~200	32~392
Pt4	0~400	32~752
Pt5	-200~600	-328~1112
jPt	-200~500	-328~932
Lin	-1999~9999	

Table 2. special alarm function selection
(used in parameter AL1M, AL2M, AL3M)

AL1M	AL2M	AL3M	Special alarm mode selection
0	0	0	Normal
1	1	1	Alarm with normal-close contact
2	2	2	Latch
3	3	3	Alarm with normal-close contact and latch
4	4	4	Alarm with inhibit
5	5	5	Alarm with inhibit and normal-close contact
6	6	6	Alarm with inhibit and latch
7	7	7	Alarm with inhibit , normal-close contact and latch
8			Alarm with on-delay timer
9			Alarm with on-delay timer but normal-close contact
10			Alarm with soaking timer
11			Alarm with soaking timer but normal-close contact

Table 3. output mode selection
(used in parameter OUTM (

0	Non
1	Single output
2	Dual output
3	Motor value control output a contact
4	Motor value control output b contact
5	Single output with transmitter
6	Single output with soft start
7	Single output with transmitter and soft start
8	Program control
9	Program control with transmitter

*NO.2~9 need to be ordered

Table 5. Error information

Display	description
<i>in1E</i>	Input 1 error
<i>AdCF</i>	A/D converter failed
<i>CJCE</i>	Cold junction compensation failed
<i>in2E</i>	Input 2 error
<i>PV</i> Blinks	PV exceeds set Ranges
<i>rRnF</i>	Ram failed
<i>intF</i>	Interface failed
<i>AutF</i>	Auto tuning failed

A How to set "SV" example: SV set at 200 °C

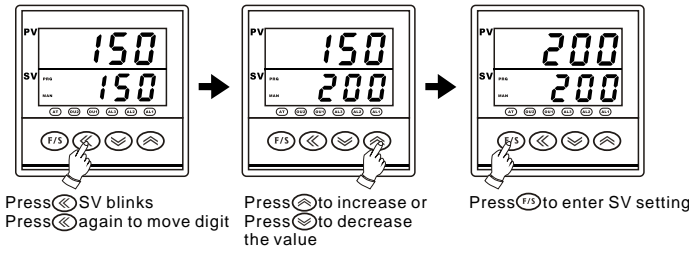

B How to set "AL1S,AL2S,AL3S" example: alarm 1 set at 20 °C

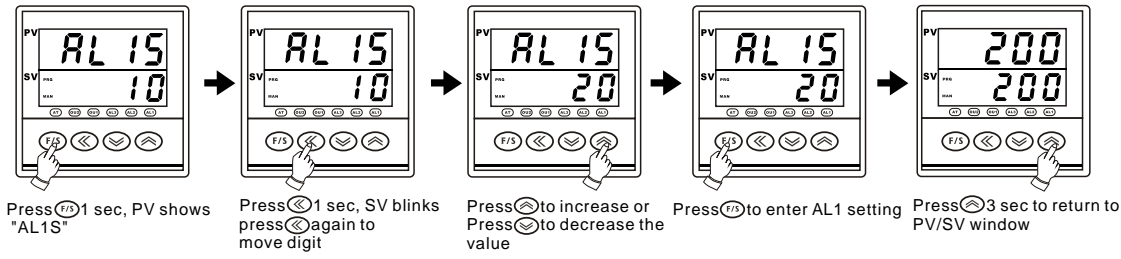

C How to set "AT" (auto tuning)

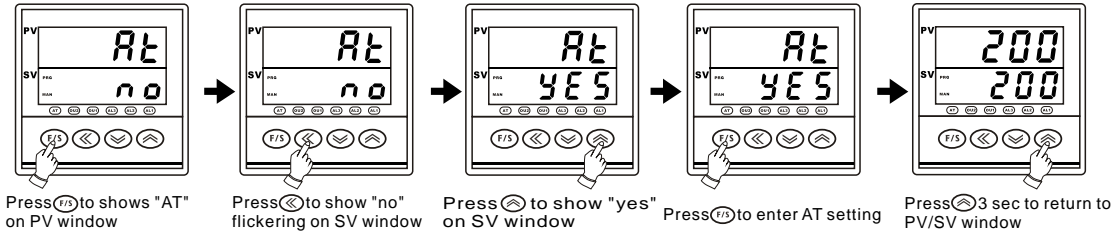

D How to enter different "level" for setting parameter

(1) Enter "CntL" level

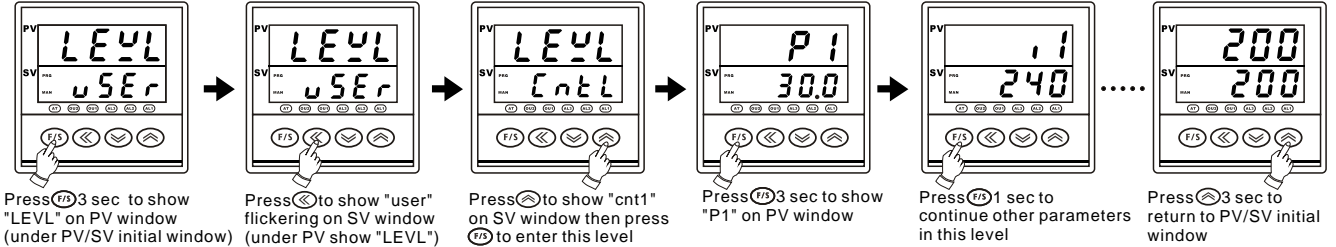

(2) Enter "Out" level

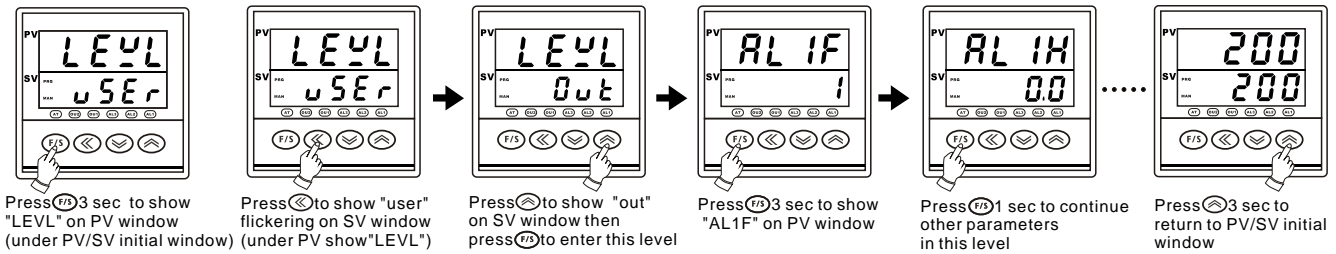

(3) Enter "inP" level

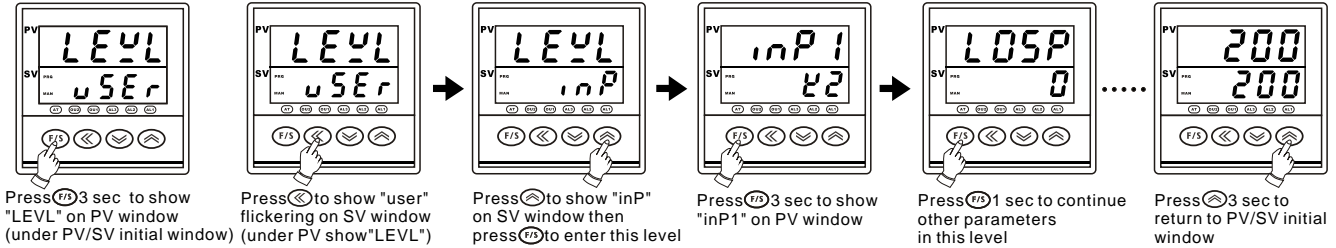

(4) Enter "SpC" level

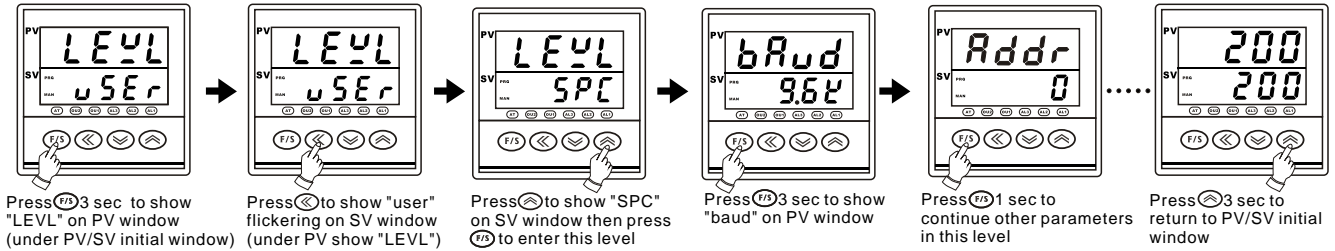

(5) Enter program level

* "OUTM" in "out" level must be selected at "8" or "9" (refer to fig 3)

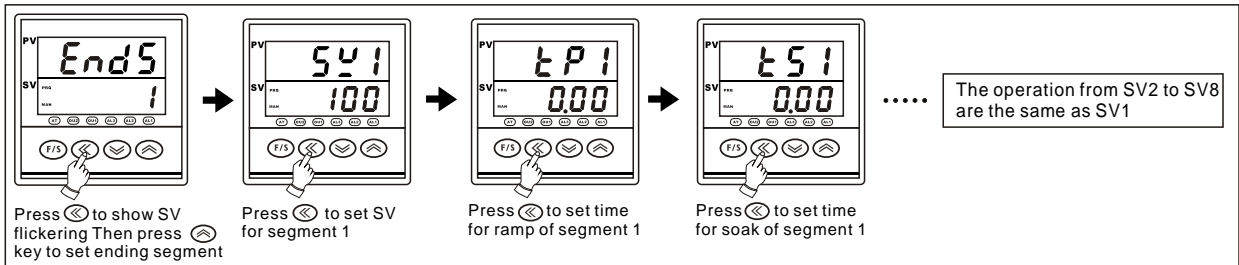
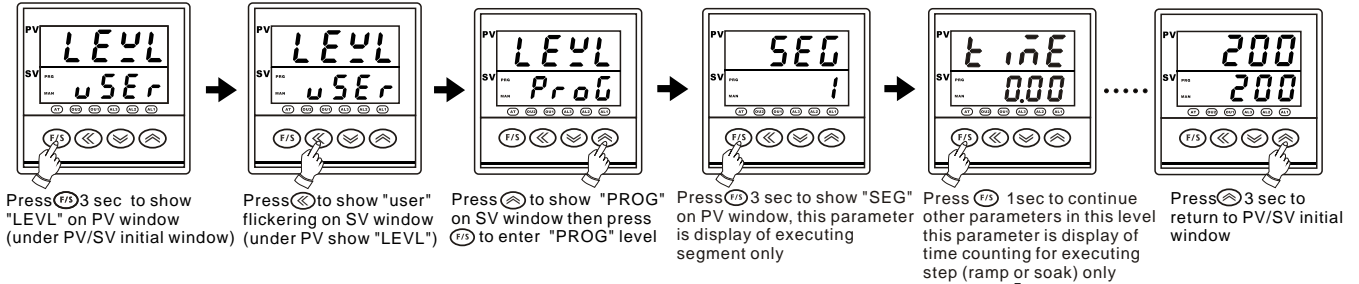

(6) Enter "Hide" level

In this level, the user can arrange parameter order or hiding from NO. 1-2 to 1-22, 2-14 to 2-17 and 3-20 to 3-27 (please refer to level parameter flow chart in page 1), but same parameter can not be arranged in 2 positions in the same time, for example you want to arrange "OUTL" to 1-3 you need to cancel it in 1-2 first. When you want to cancel or hide it you need to select "non" on the "SV"

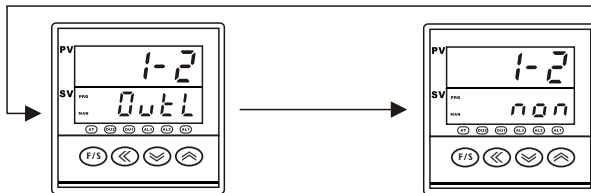
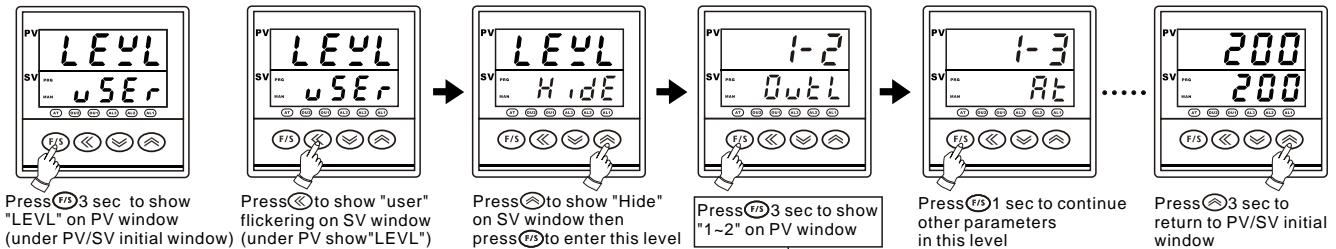

If you select "non" in 1-2 and press **F15** to enter then 1-2 will not display anything but if you select other parameter in 1-2, it will display which parameter. The operation in 1-2 to 1-22, 2-14 to 2-17 and 3-20 to 3-27 all are the same.

E How to set "LoCK" function

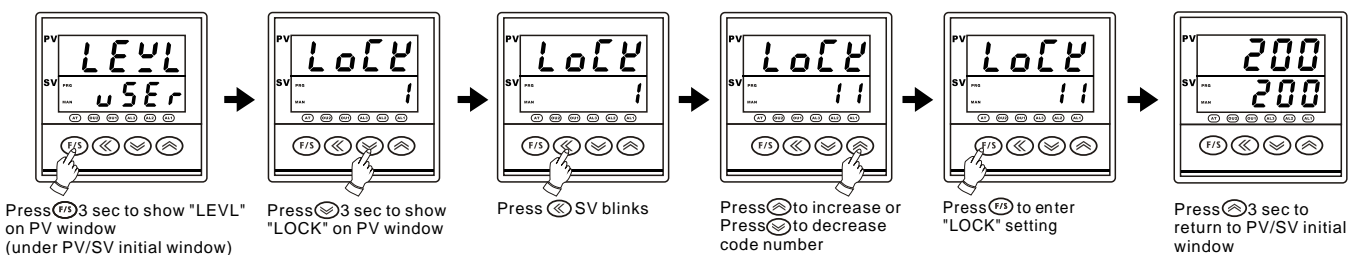

Code number for Lock function

110	all parameters are locked except PV
1101	all parameters are locked except SV
111	open "USER" level and above
122	open "CNTL" level and above
1111	open "OUT" level (Except OUTM) and above
222	open "INP" level and above
1100	open "SPC" level and above
2200	open "PROG" level and above
1122	open "HIDE" level and above
1234	open "USER" and "PROG" level only

F. How to modify input

This series controller provides free input for T/C and RTD, it doesn't need to modify hardware except analog input.

1. Analog input hardware modification

(Refer to S1~S8 on PC board back)

S1 & S2 are shorted with COM. originally,

so it needs to open S1 or S1 & S2 and to short some pads as drawing.

INPUT	S1	S2	S3	S4	S5	S6	S7	S8
TC/RTD	○	○	✕	✕	✕	✕	✕	✕
0~20MA	✕	○	✕	✕	○	✕	✕	✕
4~20MA	✕	○	✕	✕	○	✕	✕	✕
0~100MV	✕	✕	○	✕	✕	○	✕	✕
0~1V	✕	✕	✕	○	✕	○	✕	✕
0~5V	✕	✕	✕	✕	✕	○	✕	○
1~5V	✕	✕	✕	✕	✕	○	○	✕
0~10V	✕	✕	✕	✕	✕	○	✕	○

[○] short [✕] open

2. Analog input software modification

°Select "Lin" in "inpl" parameter

°Set "LoAn" in "inp" level to lowest range

°Set "HiAn" in "inp" level to highest range

3. Analog input calibration

°Enter "A1LS" parameter in "inp" level

°Provide signal for lowest range and wait for 3 sec then keep pressing  key

°Enter "A1HS" parameter in "inp" level

°Provide signal for highest range and wait for 3 sec then keep pressing  key

°Return to PV/SV initial window and provide signal for lowest range again then check if PV equals to LoAn

°Provide signal for highest range again then check if PV equals to HiAn

If it is not accuracy after calibrating, please repeat above procedure again

G. Communication Protocol (see fig 14)

PARA	INDEX	PARA	INDEX	PARA	INDEX	PARA	INDEX
LEvL	00	AL1F	30	L1i1	60	Sv7	90
LoCK	01	AL1H	31	L1d1	61	tP7	91
Sv	02	Al1t	32	L1Ar	62	tS7	92
OutL	03	AL1m	33	L1P2	63	Sv8	93
At	04	AL2F	34	L1i2	64	tP8	94
mAn	05	AL2H	35	L1d2	65	tS8	95
AL1S	06	AL2t	36	L2P1	66	1-2	96
AL1L	07	AL2m	37	L2i1	67	1-3	97
AL1U	08	AL3F	38	L2d1	68	1-4	98
AL2S	09	AL3H	39	L2Ar	69	1-5	99
AL2L	0A	AL3t	3A	L2P2	6A	1-6	9A
AL2U	0B	AL3m	3B	L2i2	6B	1-7	9B
AL3S	0C	Act	3C	L2d2	6C	1-8	9C
AL3L	0D	Outm	3D	L3P1	6D	1-9	9D
AL3U	0E	O1LS	3E	L3i1	6E	1-10	9E
SOAK	0F	O1HS	3F	L3d1	6F	1-11	9F
rAmP	10	AO	40	L3Ar	70	1-12	A0
PvoF	11	O2LS	41	L3p2	71	1-13	A1
Pvrr	12	O2HS	42	L3i2	72	1-14	A2
SvoF	13	t1SS	43	L3d2	73	1-15	A3
Ct	14	t1On	44	L4P1	74	1-16	A4
HbA	15	t1ES	45	L4i1	75	1-17	A5
LbA	16	t1oF	46	L4d1	76	1-18	A6
Lbd	17	t2SS	47	L4Ar	77	1-19	A7
rPtm	18	t2On	48	L4p2	78	1-20	A8
P1	19	t2ES	49	L4i2	79	1-21	A9
i1	1A	t2oF	4A	L4d2	7A	1-22	AA
d1	1B	inP1	4B	SEG	7B	2-14	AB
Ct1	1C	LoSP	4C	TimE	7C	2-15	AC
HSt1	1D	HiSP	4D	EndS	7D	2-16	AD
AotF	1E	LoAn	4E	Sv1	7E	2-17	AE
Ar	1F	HiAn	4F	tP1	7F	3-20	AF
P2	20	A1LS	50	tS1	80	3-21	B0
i2	21	A1HS	51	Sv2	81	3-22	B1
d2	22	unit	52	tP2	82	3-23	B2
Ct2	23	dp	53	tS2	83	3-24	B3
HSt2	24	FiLt	54	Sv3	84	3-25	B4
db	25	inP2	55	tP3	85	3-26	B5
SSv	26	A2LS	56	tS3	86	3-27	B6
Sout	27	A2HS	57	Sv4	87		
StmE	28			tP4	88		
rUCy	29	bAud	59	tS4	89		
rPt	2A	Addr	5A	Sv5	8A		
StAt	2B	LEv1	5B	tP5	8B		
PvSt	2C	LEv2	5C	tS5	8C		
wAit	2D	Lev3	5D	Sv6	8D		
Pid	2E	LvSL	5E	tP6	8E		
EndP	2F	L1P1	5F	tS6	8F		
						Pv	100

Mounting procedures

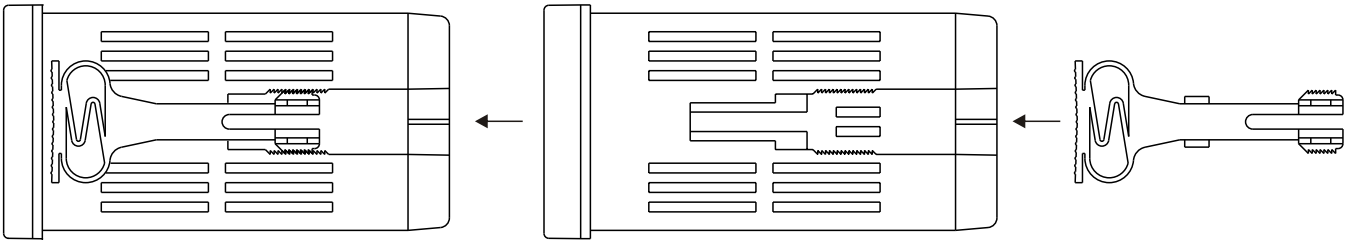

Dimension

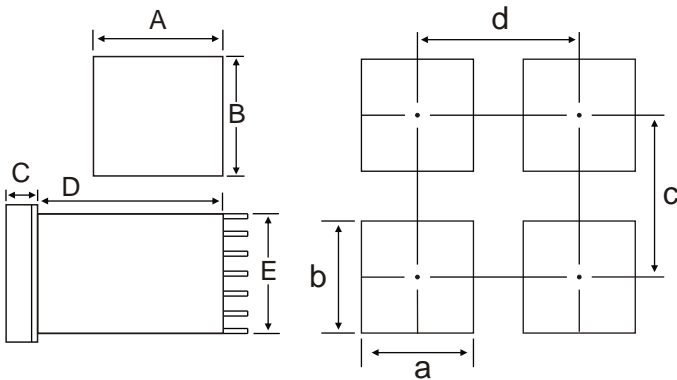

Type	A	B	C	D	E	a	b	c	d
MC-5838	96	96	10.5	83	90	$91_{-0}^{+0.5}$	$91_{-0}^{+0.5}$	120	120
MC-5738	72	72	10.5	83	67	$68_{-0}^{+0.5}$	$68_{-0}^{+0.5}$	100	100
MC-5638	96	48	10.5	83	43	$91_{-0}^{+0.5}$	$46_{-0}^{+0.5}$	70	120
MC-5538	48	96	10.5	83	90	$46_{-0}^{+0.5}$	$91_{-0}^{+0.5}$	120	70
MC-5438	48	48	10.5	83	45	$46_{-0}^{+0.5}$	$46_{-0}^{+0.5}$	70	70

Available terminal

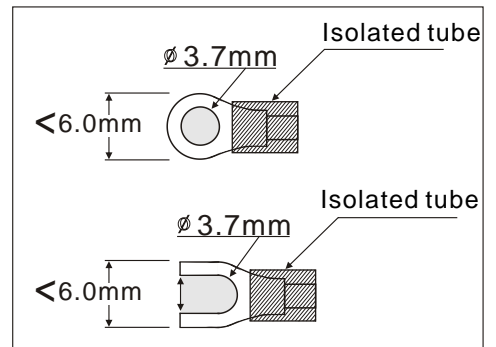

External terminal

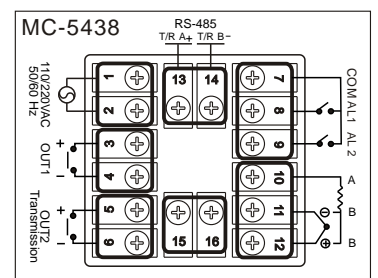
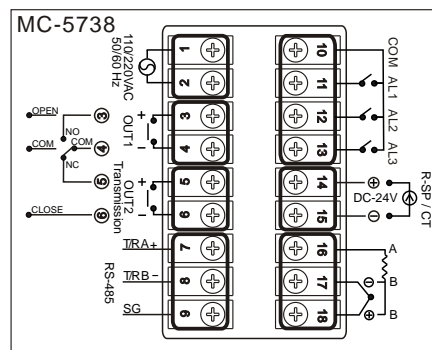
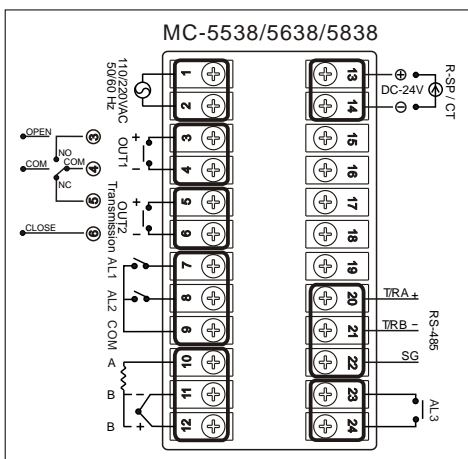

SPECIFICATIONS

PV Input	Type of Input	TC (K,J,T,R,E,S,B,N)
		RTD (Pt100, JPt100)
		Linear(1-5V, 4-20mA)
	Input Sampling Time	300 ms
Indication	PV/SV Indication	4-digit
	Constant Value Storage System	Non-volatile memory (E ² PROM)
Control Mode	Proportional Band (P)	0.0~3000
	Integral Time (I)	0~3600
	Derivative Time (D)	0~900
	Cycle Time	0~150
	Dead Band	0.0~200.0
Output	Relay Output Relay	Contact, SPDT 3A/240VAC
	Voltage Output	Voltage Pulse
	Linear Output	4~20mA, 1-5V ,
	Motor Control Output	Open loop motor valve
Alarm	Channel	3 Channels (Optional)
Communication	Type of Communication	RS-232, RS-485
General Specifications	Power Supply Voltage & Frequency	AC 90~260V, 50/60Hz
	Power Consumption	<3.5VA
	Ambient Temperature	-10° ~ 55°
	Ambient Humidity	0~80% RH

ORDERING INFORMATION

A
B C D
E F G
 M C - 5438 - 101 - 000

A: Type (Dimension) MC-5438 = 48x48mm (DIN 1/16), MC-5538 = 48x96mm (DIN 1/8), MC-5638 = 96x48mm (DIN 1/8), MC-5838 = 96x96mm (DIN 1/4)), MC-5738 = 72x72mm	
B: Output 1 0=NONE 1=Relay, contact, SPDT 3A/240VAC 2=Volt, voltage pulse, 20VDC/20MA 3= mA Curent, 4~20mA 4=Open loop circuit servo motor control A=0~5V B=0~10V C=1~5V D=2~10V	E: Transmission 0=None 1=4~20mA (Adjustable) 2=0~20mA (Adjustable) A=0~5V B=0~10V C=1~5V D=2~10V
C: Output 2 0=NONE 1=Relay, contact, SPDT 3A/240VAC 2=Volt, voltage pulse, 20VDC/20MA 3= mA Curent, 4~20mA A=0~5V B=0~10V C=1~5V D=2~10V	F: Input 2 0=None 1=4~20mA remote set point 2=0~20mA remote set point 3=CT for heater break alarm A=0~5V remote set point B=0~10V remote set point C=1~5V remote set point D=2~10V remote set point
D: Alarm 0 = NONE 1 = Alarm x 1 2 = Alarm x 2 3 = Alarm x 3	G: Communication 0 = None 1 = RS-232 2 = RS-485