

SÜDMO

BALL VALVES

KUGELHÄHNE

3.3

CONTENTS

- 3.3.2 GENERAL INFORMATION AND TECHNICAL SPECIFICATION
- 3.3.4 BALL VALVES, SANDWICH STYLE BETWEEN SMALL FLANGES
- 3.3.6 BALL VALVE ACCESSORIES AND SPARE PARTS

INHALT

- 3.3.2 ALLGEMEINE INFORMATIONEN UND TECHNISCHE DATEN
- 3.3.4 KUGELHÄHNE, ZWISCHENSPELL-KLEINFLANSCHAUSFÜHRUNG
- 3.3.6 KUGELHAHN ZUBEHÖR UND ERSATZTEILE

SÜDMO KUGELHÄHNE

BALL VALVES - KUGELHÄHNE

PENTAIR SÜDMO BALL VALVES
VERSATILE AND ROBUST VALVE
TECHNOLOGY

Ball Valve

Sandwich Style between Small Flanges
(Waver Type), pneumatic

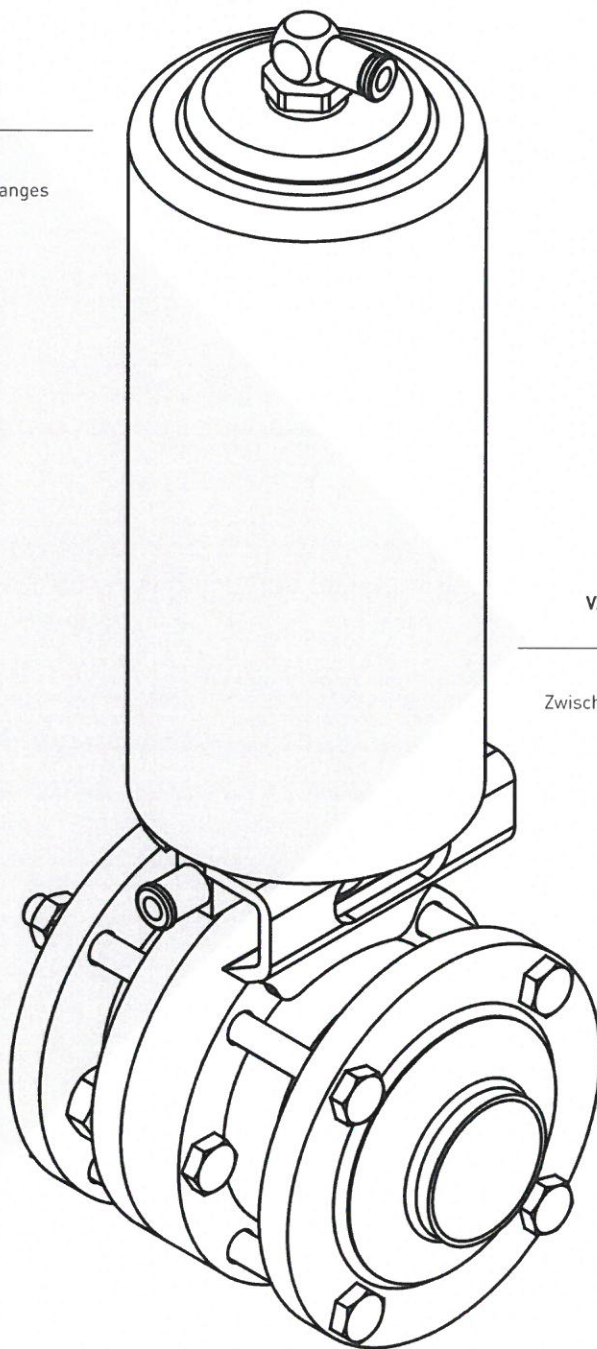

PENTAIR SÜDMO KUGELHÄHNE
VARIANTENREICHE UND ROBUSTE
VENTILTECHNIK

Kugelhahn

Zwischenspann-Kleinflanschausführung,
pneumatisch



SÜDMO KUGELHÄHNE

BALL VALVES - KUGELHÄHNE

TECHNICAL SPECIFICATION	
Materials	Product wetted parts 1.4404 (AISI 316 L), 1.4307 (AISI 304 L)
	Optional 1.4435 (AISI 316 L) Other materials on request
	Parts not product wetted 1.4301 (AISI 304), 1.4307 (AISI 304 L)
Sealing Elements	Sealing materials (FDA) EPDM-PTFE Other sealing materials on request
Temperatures	Continuous operating temperature EPDM-PTFE 120° C / 245° F*
	Sterilization temperature EPDM-PTFE 135° C / 275° F* (approx. 20 min.)
Pressures	Operating pressure 10 bar (145 psi)
	Control pressure Min. 6 bar (87 psi) - max. 8 bar (116 psi)
Surfaces	Product wetted surfaces Ra ≤ 0,8 µm
	Surfaces not product wetted Bright-turned, Ra 1,6 µm
	Optional Surfaces product wetted e-polished, higher quality surfaces on request

* Depending on operating parameters

TECHNISCHE DATEN	
Werkstoffe Edelstahl	Produktberührte Teile 1.4404 (AISI 316 L), 1.4307 (AISI 304 L)
	Optional 1.4435 (AISI 316 L) Andere Werkstoffe auf Anfrage
	Nicht produktberührte Teile 1.4301 (AISI 304), 1.4307 (AISI 304 L)
Dichtungselemente	Dichtungswerkstoffe (FDA) EPDM-PTFE Andere Dichtwerkstoffe auf Anfrage
Temperaturen	Dauerbetriebstemperatur EPDM-PTFE 120° C / 245° F*
	Sterilisationstemperatur EPDM-PTFE 135° C / 275° F* (ca. 20 min.)
Drücke	Betriebsdruck 10 bar (145 psi)
	Steuerdruck Min. 6 bar (87 psi) - max. 8 bar (116 psi)
Oberflächen	Produktberührte Oberflächen Ra ≤ 0,8 µm
	Nicht produktberührte Oberflächen Metallblank, Ra 1,6 µm
	Optional Produktberührte Oberflächen e-polieret, höherwertige Oberflächen auf Anfrage

* in Abhängigkeit von Betriebsparametern

BALL VALVES
SANDWICH STYLE BETWEEN SMALL FLANGES

KUGELHÄHNE
ZWISCHENSPIANN-KLEINFLANSCHAUSFÜHRUNG

3.3

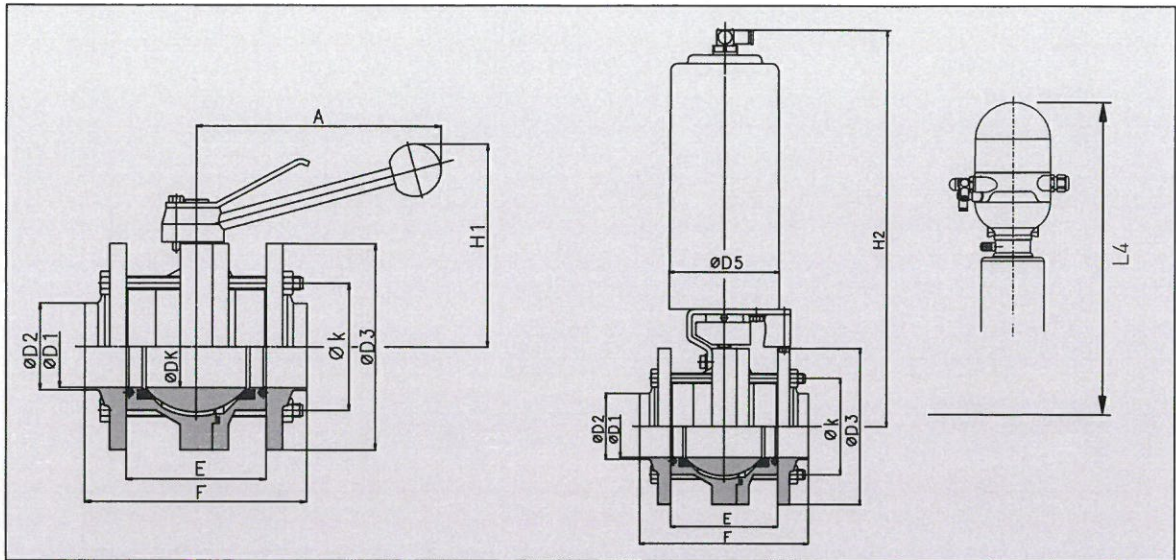

H 587
manually operated / handbetätigt

H 667 / H 687
pneumatically operated / pneumatisch betätigt

sandwich style between small flanges (waver type) / Zwischenspann-Kleinflanschausführung

METRIC/METRISCH	ØD1	ØD2	ØD3	ØD5	A	H1	H2	E	F	Øk	L4	ØDk	kg
10	10	13	59	88	150	90	271	50	100	44	463	10	1.4 / 4.6
15	16	19	63.5	88	150	92	273	50	100	50	465	16	1.5 / 4.7
20	20	23	70	88	150	95	276	56	106	57	465	20	1.8 / 5.0
25	26	29	84	88	177	113	283	67	117	67	476	26	2.9 / 6.0
32	32	35	95	88	177	119	289	72	122	80	482	32	3.5 / 6.7
40	38	41	109	88	177	126	296	76	126	93	489	38	4.5 / 7.7
50	50	53	126	88	177	134	304	86	136	110	497	50	5.8 / 8.9
65	66	70	139	127	216	152	362	109	159	125	555	66	9.2 / 18.1
80	81	85	159	127	216	162	370	126	176	145	563	81	12.3 / 21.1
100	100	104	198	127	216	181	391	156	216	180	590	100	22.3 / 32.1
OD-TUBE/ZOLL	ØD1	ØD2	ØD3	ØD5	A	H1	H2	E	F	Øk	L4	ØDk	kg
1.0"	22.1	25.4	84	88	177	113	283	67	117	67	476	26	2.9 / 6.0
1.5"	34.8	38.1	109	88	177	126	296	76	126	93	480	38	4.5 / 7.7
2.0"	47.5	50.8	126	88	177	134	304	86	136	110	497	50	5.8 / 8.9
2.5"	60.2	63.5	139	127	216	152	362	109	159	125	555	66	9.2 / 18.1
3.0"	72.9	76.2	159	127	216	162	370	126	176	145	563	81	12.3 / 21.1
4.0"	97.6	101.6	198	127	216	181	391	156	216	180	590	100	22.3 / 32.1



KUGELHÄHNE
ZWISCHENSPIANN-KLEINFLANSCHAUSFÜHRUNG

BALL VALVES
SANDWICH STYLE BETWEEN SMALL FLANGES

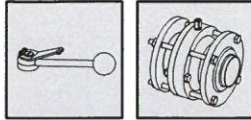

Ball Valve (PTFE-EPDM) / Kugelhahn (PTFE-EPDM)

H 587 manual, handle stainless steel / **handbetätigt**, Schalthebel Edelstahl

1.4404 (AISI 316 L)

1.4404 (AISI 316 L)

METRIC/METRISCH	ID-NO.	PRICE/PREIS	OD-TUBE/ZOLL	ID-NO.	PRICE/PREIS
10	S0004497	o.r. / a.A.	1.0"	S0004496	413,00 €
15	S0004711	o.r. / a.A.	1.5"	S0004732	509,00 €
20	S0004712	413,00 €	2.0"	S0004733	565,00 €
25	S0004713	413,00 €	2.5"	S0004386	834,00 €
32	S0004714	484,00 €	3.0"	S0004387	877,00 €
40	S0001360	509,00 €	4.0"	S0004734	2059,00 €
50	S0004715	565,00 €			
65	S0004477	834,00 €			
80	S0004716	877,00 €			
100	S0004717	2059,00 €			

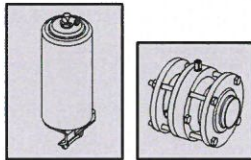

Ball Valve (PTFE-EPDM) / Kugelhahn (PTFE-EPDM)

H 667 pneumatic, air to open-spring to close / **pneumatisch**, luftöffnend-federschließend

1.4404 (AISI 316 L)

1.4404 (AISI 316 L)

METRIC/METRISCH	ID-NO.	PRICE/PREIS	OD-TUBE/ZOLL	ID-NO.	PRICE/PREIS
10	2910295	o.r. / a.A.	1.0"	2910302	630,00 €
15	2910296	o.r. / a.A.	1.5"	2910303	726,00 €
20	2910297	630,00 €	2.0"	2910304	782,00 €
25	2910298	630,00 €	2.5"	S0004736	1579,00 €
32	2910299	701,00 €	3.0"	S0004417	1623,00 €
40	2910300	726,00 €	4.0"	S0004737	2804,00 €
50	2910301	782,00 €			
65	S0004476	1579,00 €			
80	S0004301	1623,00 €			
100	S0004710	2804,00 €			

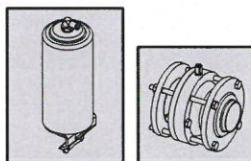

Ball Valve (PTFE-EPDM) / Kugelhahn (PTFE-EPDM)

H 687 pneumatic, air to open-air to close / **pneumatisch**, luftöffnend-luftschließend

ID-Numbers on request, prices correspond to the related air to open-spring to close variant H 667
ID-Nummern auf Anfrage, Preise entsprechen den jeweiligen Nennweiten der luftöffnend-federschließenden Variante H 667

Sets of Seals for Ball Valves Dichtungssätze für Kugelhähne

PTFE-EPDM

SIZES/NENNWEITEN	ID-NO.	PRICE/PREIS
10	0912584	23,60 €
15	0090506	37,70 €
20	0205559	40,10 €
25 / 1.0"	0161943	42,50 €
32	0089680	64,90 €
40 / 1.5"	0442137	68,40 €
50 / 2.0"	0385153	71,90 €
65 / 2.5"	0289975	75,50 €
80 / 3.0"	0565655	115,60 €
100 / 4.0"	0021220	116,80 €

Additional O-Ring necessary for Ball Valves Sandwich Style between Small Flanges H 587/H 667/H 687

Zusätzlicher O-Ring erforderlich für Kugelhähne Zwischenspann-Kleinflanschausführung H 587/H 667/H 687

METRIC/METRISCH	EPDM		FKM		HNBR		VMQ	
	ID-NO.	PRICE/PREIS	ID-NO.	PRICE/PREIS	ID-NO.	PRICE/PREIS	ID-NO.	Price/Preis
10	2912859	3,00 €	2101380	9,00 €	2003750	6,00 €	2101396	6,00 €
15	2912860	3,20 €	2101379	9,60 €	2130803	6,40 €	0962258	6,40 €
20	2912861	3,40 €	2101378	10,20 €	2101603	6,80 €	0962266	6,80 €
25	2912862	3,50 €	2101377	10,50 €	2130810	7,00 €	0497925	7,00 €
32	2912863	3,80 €	2101376	11,40 €	2130814	7,60 €	0544130	7,60 €
40	2912864	4,00 €	2101375	12,00 €	2130818	8,00 €	2101397	8,00 €
50	2912865	4,30 €	2101374	12,90 €	2130828	8,60 €	2101398	8,60 €
65	2912866	5,00 €	2101373	15,00 €	2130789	10,00 €	0544171	10,00 €
80	2912867	6,60 €	2101372	19,80 €	2130787	13,20 €	0962274	13,20 €
100	2912868	7,50 €	2101371	22,50 €	2130844	15,00 €	0962282	15,00 €

OD-TUBE/ZOLL	EPDM		FKM		HNBR		VMQ	
	ID-NO.	PRICE/PREIS	ID-NO.	PRICE/PREIS	ID-NO.	PRICE/PREIS	ID-NO.	Price/Preis
1.0"	2912889	3,50 €	2101386	10,50 €	2130808	7,00 €	2101402	7,00 €
1.5"	2912890	4,00 €	2101385	12,00 €	2130816	8,00 €	2101403	8,00 €
2.0"	2912891	4,30 €	2101384	12,90 €	2130826	8,60 €	2101404	8,60 €
2.5"	2159465	5,00 €	2101383	15,00 €	2130834	10,00 €	2101401	10,00 €
3.0"	2912893	6,60 €	2101382	19,80 €	2130837	13,20 €	2101400	13,20 €
4.0"	2159455	7,50 €	2101381	22,50 €	2130843	15,00 €	2101399	15,00 €

Sets of Seals for Pneum. Stainless Steel Actuator Dichtungssätze für pneum. Drehantrieb

air to open-spring to close
luftöffnend-federschl.

air to open-air to close
luftöffnend-luftschl.

SIZES/NENNWEITEN	NBR		NBR	
	ID-NO.	PRICE/PREIS	ID-NO.	PRICE/PREIS
DN 10-50/1"-2"	2703021	44,60 €	o.r./a.A.	44,60 €
DN 65-100/2.5"-4"	2002374	60,00 €	o.r./a.A.	60,00 €

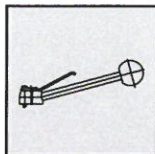

**Handle** Stainless Steel Handle**Handhebel** Edelstahlgriff**Z 590 E**

SIZES/NENNWEITEN	ID-NR./ID-NO.	PRICE/PREIS
10-20	2130374	18,00 €
25-50 / 1.0"-2.0"	2025319	18,00 €
65-100 / 2.5"-4.0"	0231894	67,00 €

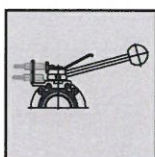
**Handle** Stainless Steel Handle

Including Mounting Set for 2 Proximity Switches M12 round (without Proximity Switches)

Handhebel Edelstahlgriff

Inklusive Anbausatz für 2 Rückmelder M12 rund (ohne Näherungsinitiatoren)

Z 590 ER

SIZES/NENNWEITEN	ID-NR./ID-NO.	PRICE/PREIS
10	2142821	58,00 €
15	2142820	58,00 €
20	2142819	58,00 €
25-32 / 1.0"	2142620	58,00 €
40-50 / 1.5"-2.0"	2019242	58,00 €
65 / 2.5"	2142818	133,00 €
80 / 3.0"	o.r./a.A.	o.r. / a.A.
100 / 4.0"	o.r./a.A.	o.r. / a.A.

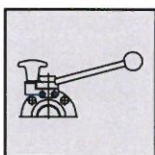
**Handle** Stainless Steel Handle with Continuous Stop**Handhebel** Edelstahlgriff mit kontinuierlicher Arretierung**Z 580 KK**

SIZES/NENNWEITEN	ID-NR./ID-NO.	PRICE/PREIS
General / Generell	o.r./a.A.	o.r. / a.A.

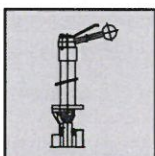
**Handle Extension**
Schalthebelverlängerung

SIZES/NENNWEITEN	ID-NR./ID-NO.	PRICE/PREIS
General / Generell	o.r./a.A.	o.r. / a.A.

Stainless Steel Actuator, Pneumatic incl. mounting set for 2 proximity switches M12 round
Drehantrieb, pneumatisch inklusive Anbausatz für 2 Rückmelder M12 rund
Z 690 K for Ball Valve / für Kugelhahn

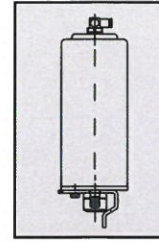
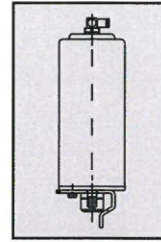
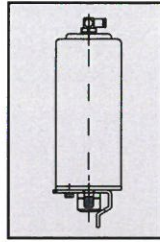

air to open-spring to close
luftöffnend-federschließend

spring to open-air to close
federöffnend-luftschließend

air to open-air to close
luftöffnend-luftschließend

SIZES/NENNWEITEN	ID-NO.	PRICE/PREIS	ID-NO.	PRICE/PREIS	ID-NO.	PRICE/PREIS
10	2707073	242,00 €	2707085	242,00 €	2707079	o.r. / a.A.
15	2707074	242,00 €	2707086	242,00 €	2707080	o.r. / a.A.
20	2707074	242,00 €	2707086	242,00 €	2707080	o.r. / a.A.
25 / 1.0"	2707075	242,00 €	2707087	242,00 €	2707081	o.r. / a.A.
32	2707075	242,00 €	2707087	242,00 €	2707081	o.r. / a.A.
40 / 1.5"	2707076	242,00 €	2707088	242,00 €	2707082	o.r. / a.A.
50 / 2.0"	2707076	242,00 €	2707088	242,00 €	2707082	o.r. / a.A.
65 / 2.5"	2707077	808,00 €	2707089	808,00 €	2707083	o.r. / a.A.
80 / 3.0"	2707078	808,00 €	2707090	808,00 €	2707084	o.r. / a.A.
100 / 4.0"	2707077	808,00 €	2707089	808,00 €	2707083	o.r. / a.A.

3.3

